



KONICA MINOLTA

DiMAGE Z20



E INSTRUCTION MANUAL

BEFORE YOU BEGIN

Thank you for purchasing this digital camera. Please take the time to read through this instruction manual so you can enjoy all the features of your new camera. Check the packing list before using this product. If any items are missing, immediately contact your camera dealer.

DiMAGE Z20 digital camera
Neck strap NS-DG800
Lens cap LF-243B
Video cable VC-400
USB cable USB-3
4 AA alkaline batteries
DiMAGE Viewer CD-ROM
DiMAGE Z20 instruction manual
DiMAGE Viewer instruction manual
Warranty card

This product is designed to work with accessories manufactured and distributed by Konica Minolta. Using accessories or equipment not endorsed by Konica Minolta may result in unsatisfactory performance or damage to the product and its accessories.

Konica Minolta is a trademark of Konica Minolta Holdings, Inc. DiMAGE is a trademark of Konica Minolta Photo Imaging, Inc. Apple, Macintosh, and Mac OS are registered trademarks of Apple Computer Inc. Microsoft and Windows are registered trademarks of the Microsoft Corporation. The official name of Windows is Microsoft Windows Operating System. Pentium is a registered trademark of the Intel Corporation. Power PC is a trademark of the International Business Machines Corporation. QuickTime is a trademark used under license. All other brand and product names are trademarks or registered trademarks of their respective owners.

FOR PROPER AND SAFE USE

Read and understand all warnings and cautions before using this product.

WARNING

Using batteries improperly can cause them to leak harmful solutions, overheat, or explode which may damage property or cause personal injury. Do not ignore the following warnings.

- Only use the batteries specified in this instruction manual.
 - Do not install the batteries with the polarity (+/–) reversed.
 - Do not use batteries which show wear or damage.
 - Do not expose batteries to fire, high temperatures, water, or moisture.
 - Do not attempt to short, or disassemble batteries.
 - Do not store batteries near or in metallic products.
 - Do not mix batteries of different types, brands, ages, or charge levels.
 - Do not charge alkaline batteries.
 - When recharging rechargeable batteries, only use the recommended charger.
 - Do not use leaking batteries. If fluid from the batteries enters your eye, immediately rinse the eye with plenty of fresh water and contact a doctor. If fluid from the batteries makes contact with your skin or clothing, wash the area thoroughly with water.
 - Tape over battery contacts to avoid short-circuiting during disposal; always follow local regulations for battery disposal.
-
- Use only the specified AC adapter within the voltage range indicated on the adapter unit. An inappropriate adapter or current may cause damage or injury through fire or electric shock.
 - Do not disassemble this product. Electric shock may cause injury if a high voltage circuit inside the product is touched.
 - Immediately remove the batteries or unplug the AC adapter and discontinue use if the camera is dropped or subjected to an impact in which the interior, especially the flash unit, is exposed. The flash has a high voltage circuit which may cause an electric shock resulting in injury. The continued use of a damaged product or part may cause injuries or fire.

- Keep batteries or small parts that could be swallowed away from infants. Contact a doctor immediately if an object is swallowed.
- Store this product out of reach of children. Be careful when around children not to harm them with the product or parts.
- Do not fire the flash directly into the eyes. It may damage eyesight.
- Do not fire the flash at vehicle operators. It may cause a distraction or temporary blindness which may lead to an accident.
- Do not use the monitor while operating a vehicle or walking. It may result in injury or an accident.
- Do not use this product in a humid environment, or operate this product with wet hands. If liquid enters the product, immediately remove the batteries or unplug the AC adapter and discontinue use. The continued use of a product exposed to liquids may cause damage or injury through fire or electric shock.
- Do not use the product near inflammable gases or liquids such as gasoline, benzine, or paint thinner. Do not use inflammable products such as alcohol, benzine, or paint thinner to clean the product. The use of inflammable cleaners and solvents may cause an explosion or fire.
- When unplugging the AC adapter, do not pull on the power cord. Hold the adapter unit when removing it from an outlet.
- Do not damage, twist, modify, heat, or place heavy objects on the AC adapter cord. A damaged cord may cause damage or injury through fire or electric shock.
- If the product emits a strange odor, heat, or smoke, discontinue use. Immediately remove the batteries taking care not to burn yourself as the batteries become hot with use. The continued use of a damaged product or part may cause injuries or fire.
- Take the product to a Konica Minolta Service Facility when repairs are required.
- Handling the cord on this product may expose you to lead, a chemical known to the State of California to cause cancer, and birth defects or other reproductive harm. Wash hands after handling.

CAUTION

- Do not use or store the product in a hot or humid environment such as the glove compartment or trunk of a car. It may damage the product and batteries which may result in burns or injuries caused by heat, fire, explosion, or leaking battery fluid.
- If batteries are leaking, discontinue use of the product.
- The lens retracts when the camera is turned off. Touching the lens barrel while it is retracting may cause injury.
- The camera temperature rises with extended periods of use. Care should be taken to avoid burns.
- Burns may result if the memory card or batteries are removed immediately after extended periods of use. Turn the camera off and wait for it to cool.
- Do not fire the flash while it is in contact with people or objects. The flash unit discharges a large amount of energy which may cause burns.
- Do not apply pressure to the LCD monitor. A damaged monitor may cause injury, and the liquid from the monitor may cause inflammation. If liquid from the monitor makes contact with skin, wash the area with fresh water. If liquid from the monitor comes in contact with the eyes, immediately rinse the eyes with plenty of water and contact a doctor.
- When using the AC adapter, insert the plug securely into the electrical outlet.
- Do not use if the AC adapter cord is damaged.
- Do not cover the AC adapter. A fire may result.
- Do not obstruct access to the AC adapter; this can hinder the unplugging of the unit in emergencies.
- Unplug the AC adapter when cleaning or when the product is not in use.

ABOUT THIS MANUAL

The basic operation of this camera is covered between pages 12 and 33. This section of the manual covers the camera parts, preparation of the camera for use, and the basic camera operation for recording, viewing, and deleting images.

Many of the features of this camera are controlled with menus. The menu navigation sections concisely describe how to change menu settings. Descriptions of the settings immediately follow the navigation sections.

Names of parts	10
Getting up and running.....	12
Attaching the strap and lens cap.....	12
Inserting batteries	13
Battery condition indicator	14
Auto power save.....	14
Connecting the optional AC adapter.....	15
Changing the memory card.....	16
Turning on the camera and displays.....	17
Setting the date and time	18
Setting the menu language	19
Basic recording	20
Handling the camera	20
Using the zoom lens.....	20
Recording images automatically.....	21
Basic recording operation.....	22
Automatic Digital Subject Program Selection.....	23
Focus lock	24
Focus range.....	24
Focus signals.....	25
Special focusing situations	25
Flash modes	26
Flash range - auto-recording mode.....	27
Camera-shake warning	27
i* button.....	28
Adjusting monitor brightness	28
Digital subject programs	29
Basic playback	30
Single-frame playback and histogram display.....	30

Viewing and rotating images	31
Deleting single images	31
i+ button.....	32
Enlarged playback.....	33
Advanced recording	34
Recording mode display.....	34
Macro	35
Program (P) exposure mode.....	36
Aperture priority (A) exposure mode.....	36
Shutter priority (S) exposure mode.....	37
Manual (M) exposure mode.....	38
Movie recording.....	40
Exposure compensation.....	41
Focus area selection.....	42
Navigating the recording menus.....	43
Drive modes	45
Self-timer	46
Continuous advance.....	47
Progressive capture.....	48
Bracketing.....	49
What is an Ev?	50
Image size and image quality.....	51
Auto DSP.....	53
Digital zoom.....	53
Focus modes.....	54
White balance.....	55
Automatic white balance.....	55
Preset white balance.....	55
Custom white balance.....	56
Full-time AF.....	57
Flash mode.....	57
Flash compensation.....	57
Metering modes.....	58
Camera sensitivity - ISO.....	59
Flash range and camera sensitivity.....	59
Color mode.....	60
Contrast.....	60
Sharpness.....	61
Custom key function.....	62
Image size (Movie).....	64

Frame rate	64
Movie file sizes	64
Movie mode	65
A short guide to photography	66
Advanced playback	68
Playing back movies	68
Capturing a movie frame	69
Navigating the playback-mode menu	70
Frame-selection screen	72
Delete	73
Format	74
Lock	75
Copy and E-mail Copy	76
Slide Show	80
About DPOF	82
DPOF setup	82
Date imprint	83
Index print	83
Viewing images on a television	84
Setup menu	85
Opening the setup menu	85
Navigating the setup menu	86
LCD monitor brightness	88
Auto power save	88
Instant playback	89
Lens accessory	90
Language	90
File number (#) memory	91
Folder name	92
Date and time setup	93
Date imprinting	93
Reset default	94
Audio signals	95
Focus signal	96
Shutter FX	96
Video output	96
Transfer mode	96
Self-timer	96

Data-transfer mode	97
System requirements.....	97
Connecting the camera to a computer.....	98
Connecting to Windows 98 and 98SE.....	99
Automatic installation.....	99
Manual installation	100
Folder organization.....	102
Auto power save - data-transfer mode.....	103
Disconnecting the camera	104
Windows 98 and 98 Second Edition.....	104
Windows Me, 2000 Professional, and XP	104
Mac OS.....	105
Changing the memory card	106
Uninstalling the driver software - Windows	107
PictBridge	108
Notes on printing errors.....	109
Navigating the PictBridge menu	110
Appendix	114
Troubleshooting	114
Care and storage	116
Camera care	116
Storage.....	116
Cleaning	116
LCD monitor care.....	117
Batteries	117
Operating temperatures and conditions.....	117
Memory cards	118
Before important events and journeys	119
Copyright.....	119
Questions and service	119
QuickTime system requirements	120
Technical specifications	122

NAMES OF PARTS

* This camera is a sophisticated optical instrument. Care should be taken to keep these surfaces clean. Please read the care and storage instructions in the back of this manual (p. 116).

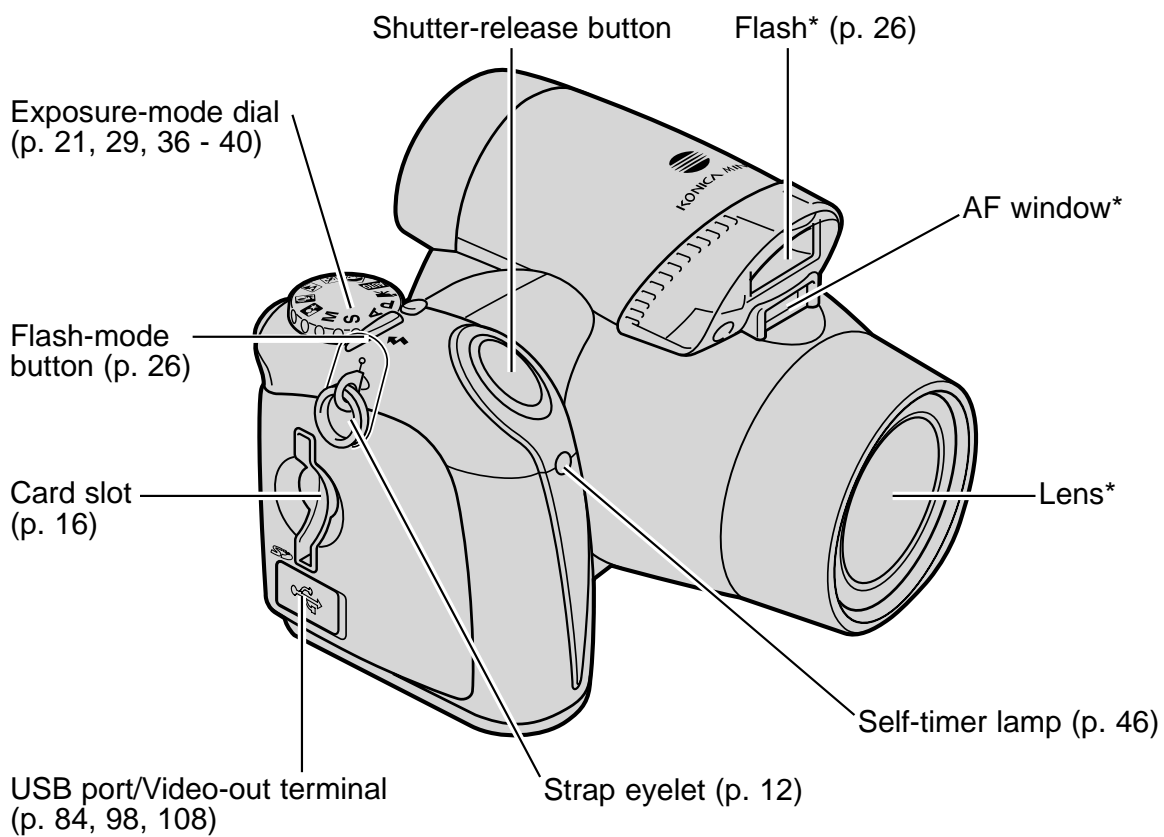

The battery-chamber door (p. 13) and tripod socket are located on the bottom of the body.

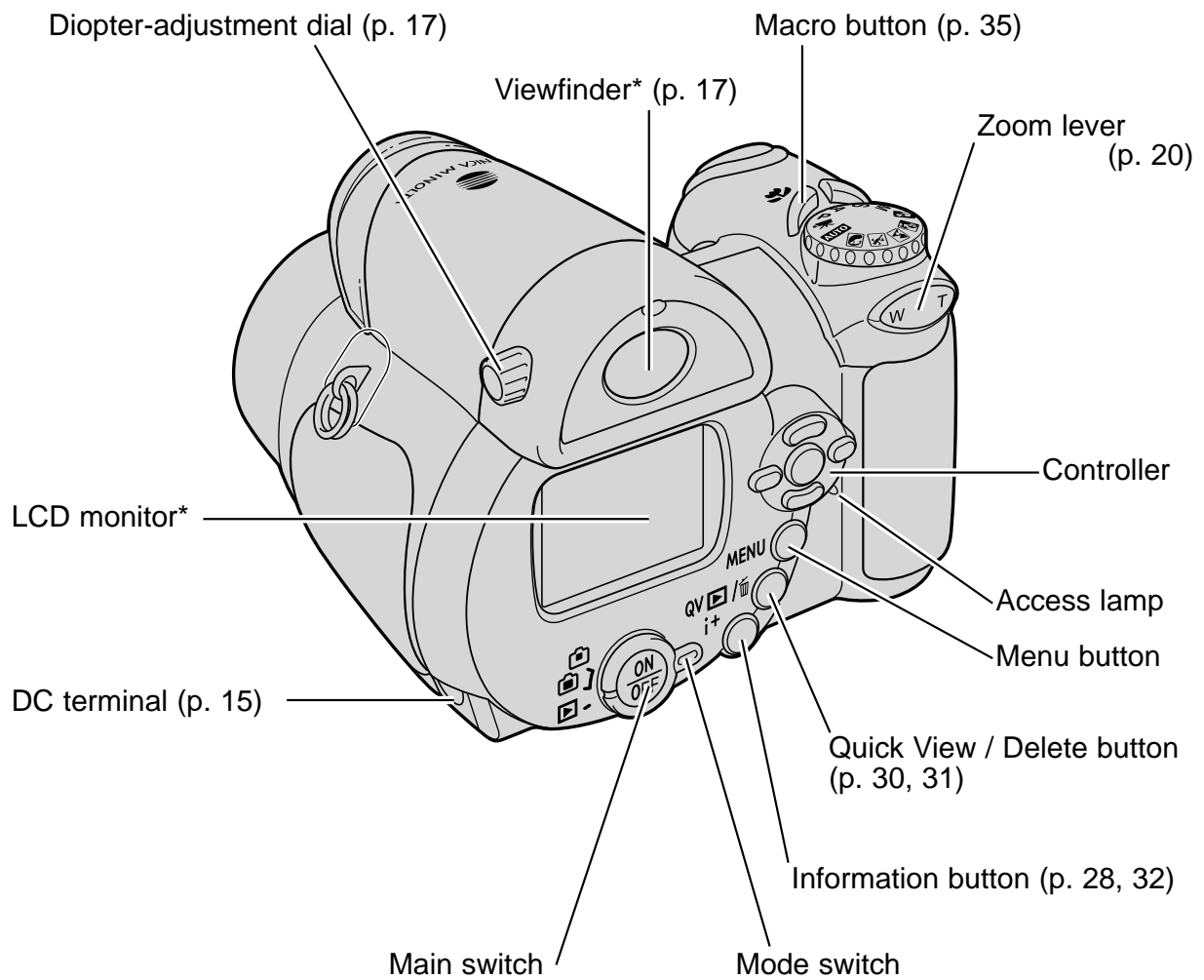

GETTING UP AND RUNNING

ATTACHING THE STRAP AND LENS CAP

Always keep the strap around your neck in the event that the camera is accidentally dropped. An optional leather neck strap, NS-DG1000, is also available from your Konica Minolta dealer. Availability varies with region.

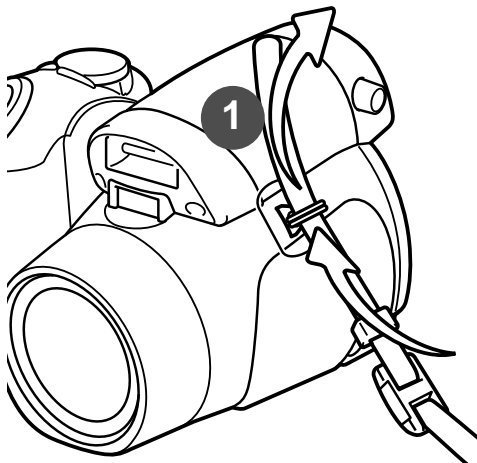

Pass the end of the neck strap through the strap eyelet on the camera body (1).

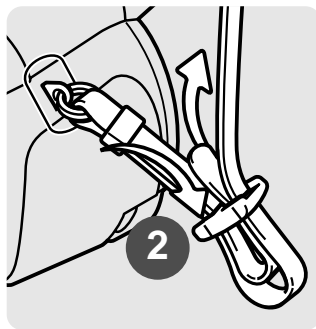

Thread the strap through the inside of the buckle as shown (2). Repeat with the other end of the strap.

Using your thumb and index finger, pinch the outside tabs of the lens cap to remove or attach. When the camera is not in use, always replace the lens cap.

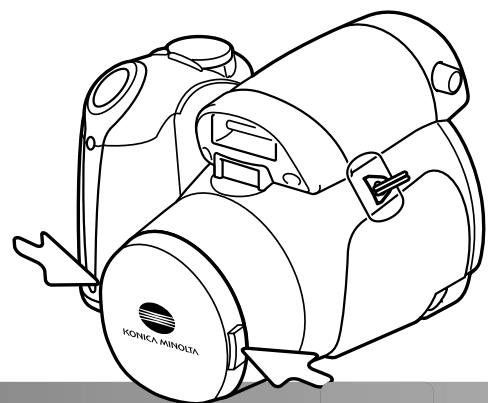

INSERTING BATTERIES

This digital camera uses four AA-size alkaline or Ni-MH batteries. Do not use other types of AA batteries. The camera should be off when replacing batteries.

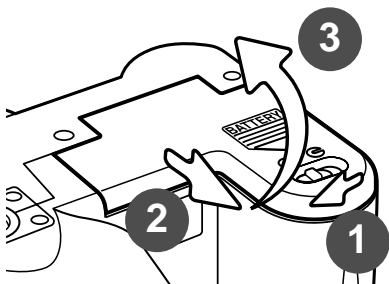

To open the battery-chamber door, slide the lock to the open position (1). Slide the door to the front of the camera (2) to release the safety catch. Lift the door to open (3).

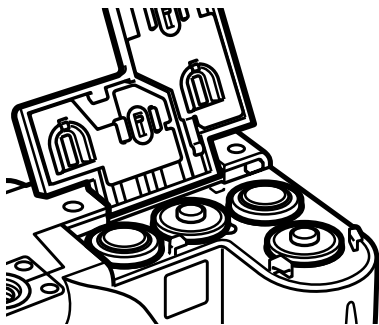

Insert the batteries as indicated on the diagram on the inside of the battery-chamber door. Confirm the positive and negative battery terminals are oriented correctly.

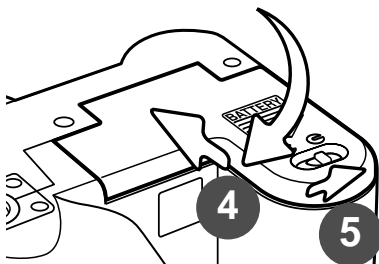

Close the battery-chamber door and slide it toward the back of the body (4) to engage the safety catch. Slide the battery-chamber lock to the close position (5).

BATTERY CONDITION INDICATOR

This camera is equipped with an automatic battery-condition indicator. When the camera is on, the battery-condition indicator appears on the monitor. If the monitor is blank, the batteries may be exhausted or installed incorrectly.



Full-battery indicator - the battery is fully charged. This indicator is displayed for three seconds on the monitor when the camera is turned on.



Low-battery indicator - battery power is low. The monitor will turn off while the flash is charging to save power.



Low-battery warning - battery power is very low. The monitor indicator is red. The battery should be replaced as soon as possible. This warning automatically appears and remains on the monitor until the battery is changed. The monitor will turn off while the flash is charging to save power. If power falls below this level, the battery-exhausted message will be displayed just before the camera shuts down. If the low-battery warning is displayed, movie recording cannot be used.

AUTO POWER SAVE

To conserve battery power, the camera turns off displays and unnecessary functions if an operation is not made within a minute. To restore power, press any button or key, or turn the exposure-mode dial to another position. The length of the auto-power-save period can be changed in section 1 of the setup menu (p. 88).

If an operation is not made within approximately 30 minutes, the camera turns off automatically. Press the main switch to turn on the camera.

CONNECTING THE OPTIONAL AC ADAPTER



Always turn off the camera before changing between power supplies.

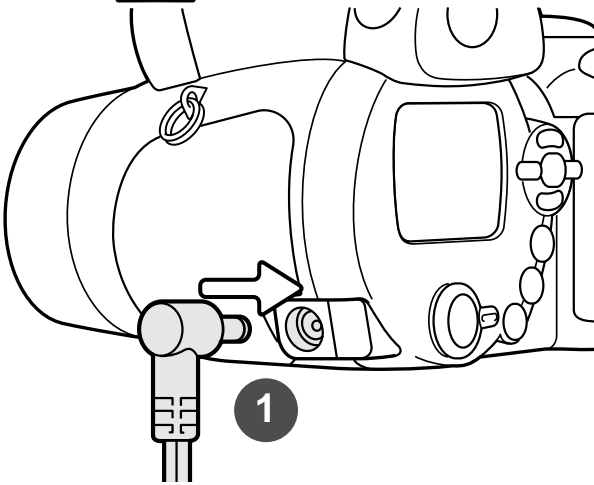

The AC Adapter AC-11 allows the camera to be powered from an electrical household outlet. The AC Adapter is recommended when the camera is interfaced with a computer or during periods of heavy use.

Insert the mini plug of the AC adapter into the DC terminal (1).

Insert the AC adapter plug into an electrical outlet.

CHANGING THE MEMORY CARD

This digital camera is equipped with a internal storage (approximately 14.5MB) so images can be recorded without a memory card. For increased memory capacity, an SD Memory Card or MultiMediaCard can be inserted into the camera. When card is inserted, the images are recorded on the card. For more about memory cards see page 118.

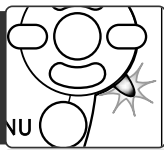

Always turn off the camera and confirm the access lamp is not lit before inserting or removing a memory card; damage and data loss may result.

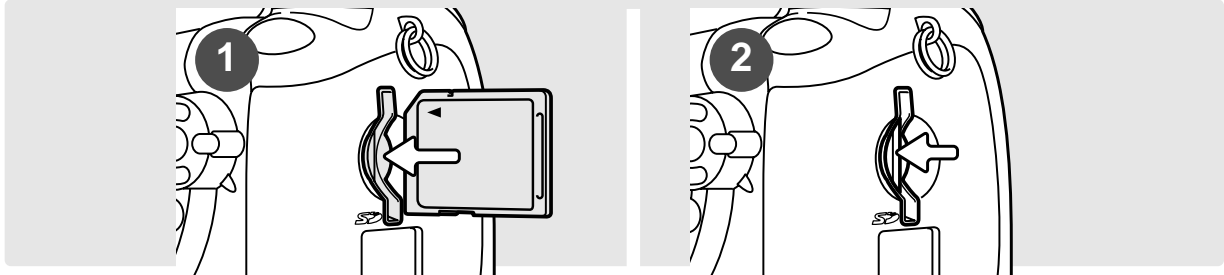

1. Insert the memory card all the way into the card slot and release; the card should catch in the slot. Insert the card so the face is toward the back of the camera. Always push the card in straight, never at an angle. Never force the card. If the card does not fit, check that it is oriented correctly.
2. To eject a memory card, press the card into the slot and release. The card can then be pulled out. Take care when removing the card as it becomes hot with use.

A memory card used in another camera may have to be formatted before being used. If the unable-to-use-card message appears, the card should be formatted with the camera. A memory card can be formatted in section 1 of the playback menu (p. 74). When a card is formatted, all the data on the card is permanently erased. If the card-error message appears, press the central button of the controller to close the window; check the Konica Minolta web site for the latest compatibility information:

North America: <http://kmpi.konicaminolta.us>
 Europe: <http://www.konicaminoltaeurope.com/>

TURNING ON THE CAMERA AND DISPLAYS

Press the main switch to turn the camera on. Pressing the switch again turns the camera off.

Around the main switch is the mode switch. This switch is used to change between the recording and playback modes as well as the selecting the between the monitor and viewfinder display.

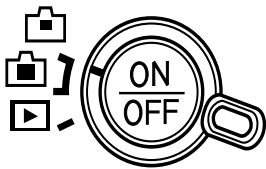
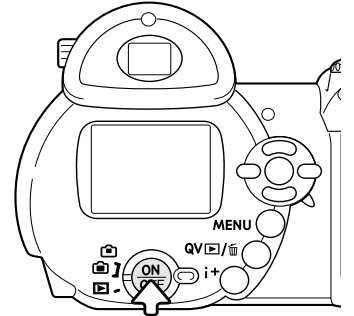

Recording mode (Viewfinder display) - the camera can record images and the monitor is viewed through the viewfinder. The viewfinder has a built-in diopter. While looking through the viewfinder, turn the diopter-adjustment dial until the monitor image is sharp

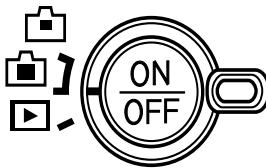
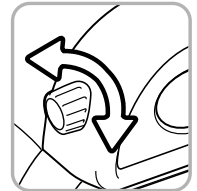

Recording mode (Monitor display) - the camera can record images and the monitor is viewed directly.

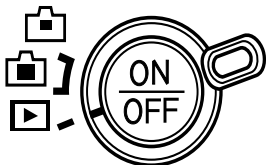

Playback mode (Monitor display) - images can be played back and edited. The monitor is viewed directly.

Camera notes

To use the viewfinder in the playback mode, press and hold the flash mode button (1) and then press and hold the information (i+) button (2) until the monitor switches to the viewfinder position.

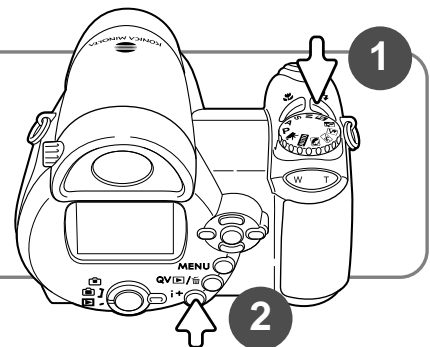

SETTING THE DATE AND TIME

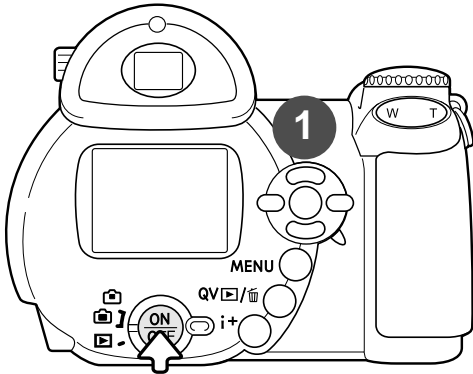

After initially inserting batteries, the camera's clock and calendar must be set. When images are recorded, the image data is saved with the date and time of recording.

If the clock and calendar have not been set, a message is displayed for a few seconds each time the camera is turned on. This message is also displayed if the clock and calendar are reset when the camera is stored without batteries for a long period.

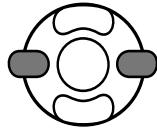
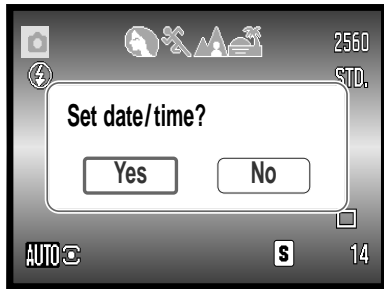

Use the left and right keys of the controller (1) to select "Yes." "No" cancels the operation.

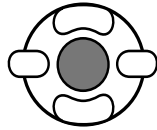

Press the center of the controller to open the date/time setup screen.

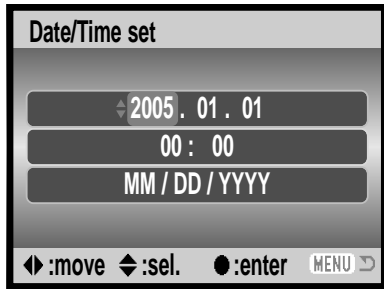

Use the left and right keys to select the item to be changed.

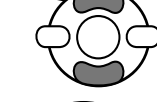

Use the up and down keys to adjust the item.

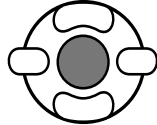

Press the central button to set the clock and calendar.

Date/Time setup screen

The date/time setup screen can be opened in section 2 of the setup menu.

SETTING THE MENU LANGUAGE

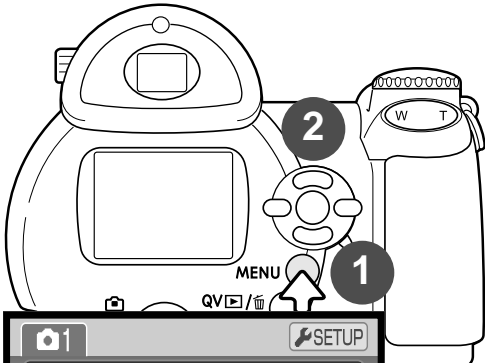

For customers in certain areas, the menu language may have to be set. Press the menu button (1) to open the menu; the appearance of the menu will depend on the position of the camera's controls.

Navigating the menu is simple. The up/down and left/right keys of the controller (2) move the cursor and change settings on the menu. The central button of the controller selects menu options and sets adjustments.

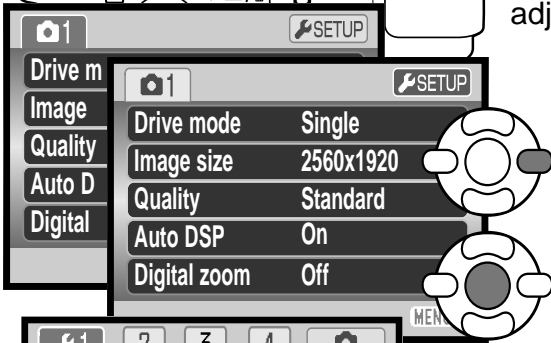

Use the right key of the controller to highlight "SETUP" at the top of the menu.

Press the central button of the controller to open the setup menu.



Use the down key to highlight the language menu option, then press the right key.

Press the central button of the controller to open the language screen.

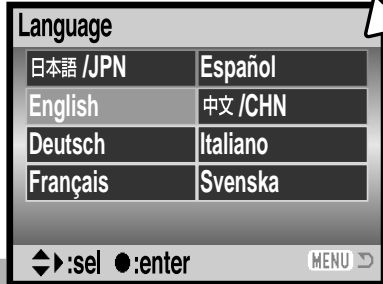

Use the four-way keys of the controller to highlight the new menu language.

Press the central button of the controller to set the language.

BASIC RECORDING

This section covers the basic operation of this camera. Thoroughly familiarize yourself with the operations in this section before moving on to the other sections in the manual.

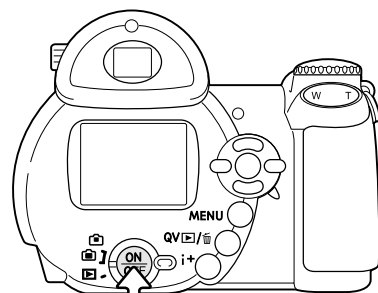

Turn on the camera. Set the mode switch to a recording position.



HANDLING THE CAMERA

While using the viewfinder or LCD monitor, grip the camera firmly with your right hand while supporting the body with your left. Keep your elbows at your side and your feet shoulder-width apart to hold the camera steadily. Take care not to cover the lens with your fingers or the strap.

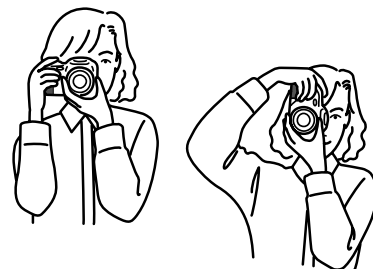

USING THE ZOOM LENS

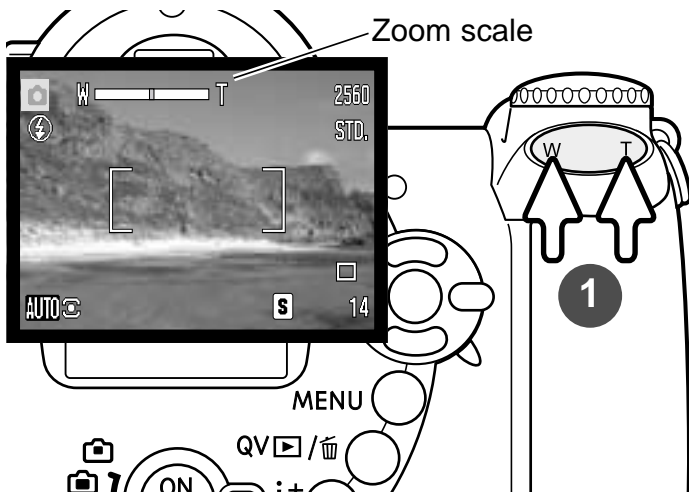

The zoom lever controls the lens (1). Pressing the right (T) side of the lever will zoom in to the telephoto position of the lens. Pressing the left (W) side of the lever will zoom out to the wide-angle position.

After zooming, the zoom scale is displayed briefly. If the digital zoom (p. 53) is active, the yellow section of the scale indicates the digital-zoom range.

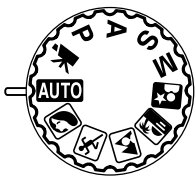

BASIC RECORDING OPERATION

The example uses auto recording. Except for movie recording, the operation for other exposure modes is the same. Automatic Digital Subject Program Selection is only available in the auto recording mode.

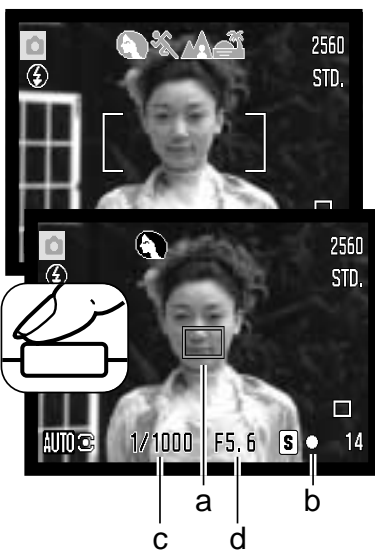

Place the subject anywhere within the focus frame. Make sure the subject is within the focus range of the lens (p. 24). For very close subjects, use the macro function (p. 35).

Press the shutter-release button partway down to lock the focus and exposure. An AF sensor (a) is displayed to indicate the subject. Automatic Digital Subject Selection will choose the appropriate exposure mode, see the facing page.

The focus signal (b) on the monitor will confirm focus lock. If the focus signal is red, the camera was unable to locate the subject. Repeat the previous steps until the signal is white. The shutter speed (c) and aperture (d) appears and turns black to indicate the exposure is locked.

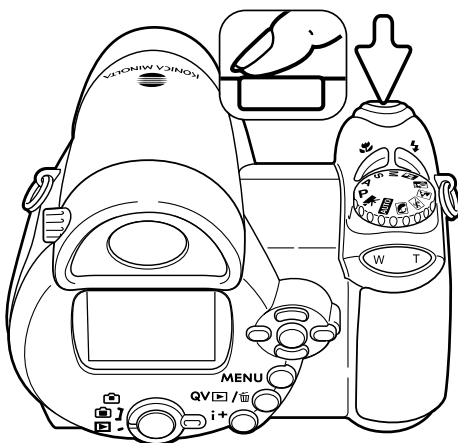

Press the shutter-release button all the way down to take the picture.



The access lamp lights indicating image data is being written to the memory card or the internal memory. Never remove or insert a memory card while data is being saved.

Camera notes

The recorded image can be previewed by continuing to hold down the shutter-release button after the image is captured. The instant-playback function can also be used (p. 89).

AUTOMATIC DIGITAL SUBJECT PROGRAM SELECTION

Automatic Digital Program Selection chooses between program autoexposure and one of five digital subject programs. The digital subject programs optimize camera setting for various conditions and subjects. Automatic Digital Subject Program Selection is only available in auto recording and can be disabled in the auto-recording menu. For information on individual subject programs, see page 29.

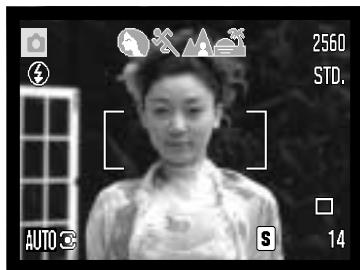

A row of gray indicators at the top on the monitor display will indicate Automatic Digital Subject Selection is active. Place the subject in the focus frames; the procedure is the same as the basic recording operation described on page 22.

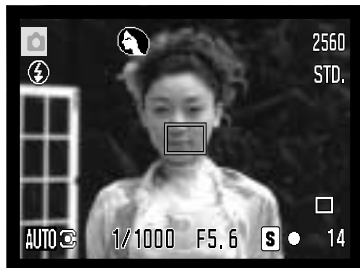

Press the shutter-release button partway down; the AF system will locate the subject and the Automatic Digital Subject Selection function will choose a subject program. If no indicators are displayed, program autoexposure is active. Press the shutter-release button all the way down to take the picture. Hold the camera steadily when the sunset subject program is selected as exposures can be long.



Program autoexposure (the Digital Subject Program indicators disappear)



Portrait



Sports action

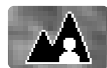

Landscape



Sunset

FOCUS LOCK

Focus lock prevents the AF system from focusing. This can be used with off-center subjects or when a special focusing situation prevents the camera from focusing (p. 25).

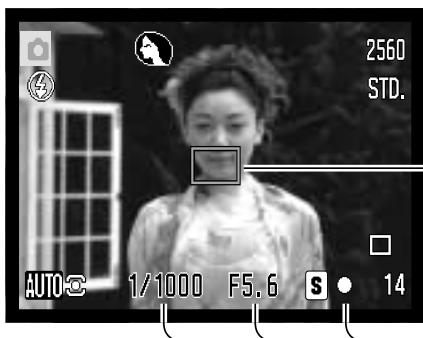

Place the subject within the focus frame. Press and hold the shutter-release button partway down.

- The focus signal indicates the focus is locked. The shutter speed and aperture value change from white to black indicating the exposure is locked.
- When the focus is set, an AF sensor is displayed on the live image to indicate the point of focus.



Without lifting your finger from the shutter-release button, recompose the subject within the image area. Press the shutter-release button all the way down to take the picture.

FOCUS RANGE

All distances are measured from the CCD. See page 35 for the marco focus range.

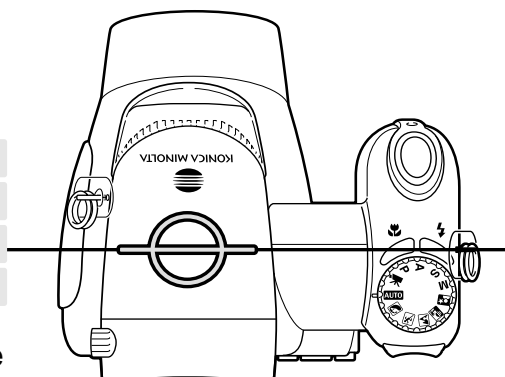

Wide-angle position
0.57m - ∞ (1.9ft - ∞)
Telephoto position
1.57m - ∞ (5.1ft - ∞)

Approximate location of CCD plane



FOCUS SIGNALS

The focus signal in the lower right corner of the LCD monitor indicates the focus status. The shutter can be released even if the camera cannot focus on the subject.

-  Focus locked.
-  Focus confirmed (P, A, S, and M continuous AF focus mode and sports action digital subject program). Exposure continuously adjusts.
-  Cannot focus. The subject is too close or a special situation is preventing the AF system from focusing.

When using the sports action digital subject program, the camera continually focuses when the shutter-release button is pressed partway down; the focus frames turn red. Keep the subject within the red focus frames. Focus lock cannot be used.

If the AF system cannot focus, focus lock can be used with object at the same distance as the main subject or the camera can be focused manually in the Digital Subject Program or program (P) exposure modes (p. 54).

SPECIAL FOCUSING SITUATIONS

The camera may not be able to focus in certain situations. If the autofocus system cannot focus on a subject, the focus signal will turn red. In this situation, focus-lock on an object at the same distance as the main subject and then recompose the image on the monitor to take the picture.

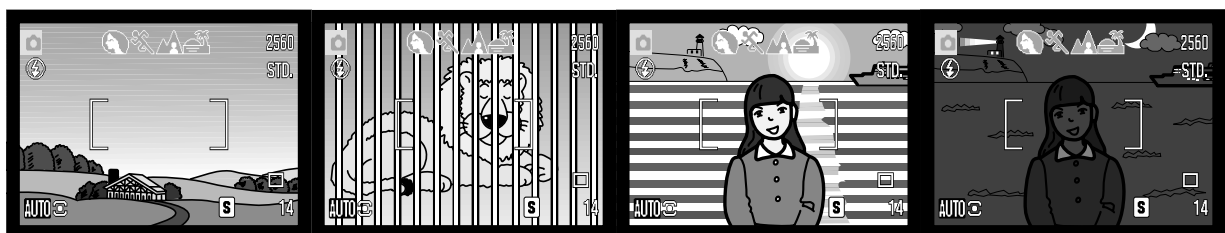

The subject in the focus frame is low in contrast.

Two subjects at different distances overlap in the focus frame.

The subject is near a very bright object or area.

The subject is too dark.

FLASH MODES

To change the flash mode, simply press the flash mode button (1) until the appropriate mode is indicated.

Autoflash - the flash fires automatically in low-light and backlit conditions.

Red-eye reduction - multiple flashes are used before the main flash burst to reduce red-eye; an effect caused by light reflected from the retina. Use in low-light conditions when taking photographs of people or animals. The pre-flashes contract the pupils of the subject's eyes.

Fill-flash - the flash fires with each exposure regardless of the amount of ambient light. Fill-flash can be used to reduce harsh shadows caused by strong direct light or sunshine.

Slow sync. - flash and ambient light exposures are balanced; red-eye reduction is used. Use slow sync. when in dark locations to reveal background details. Ask your subject not to move after the flash burst; the shutter may still be open for the background exposure. Because exposures can be long, the use of a tripod is recommended.

Flash cancel - the flash cannot fire.

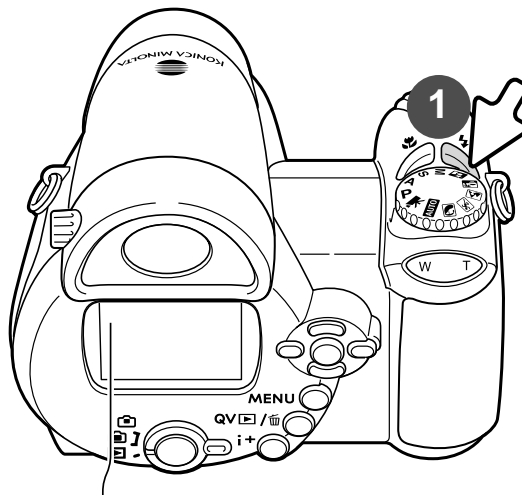

	Autoflash
	Autoflash with red-eye reduction
	Fill-flash
	Fill-flash. with red-eye reduction
	Slow sync. with red-eye reduction
	Flash cancel



FLASH RANGE - AUTO-RECORDING MODE

The camera controls the flash output automatically. For well-exposed images, the subject must be within the flash range. Distance is given from the CCD plane. Because of the optical system, the flash range is not the same at the lens' wide-angle position as it is at the telephoto position.

Wide-angle position
0.57 - 4.7m (1.87 - 15.4 ft)
Telephoto position
1.57 - 4.7m (5.15 - 15.4 ft)

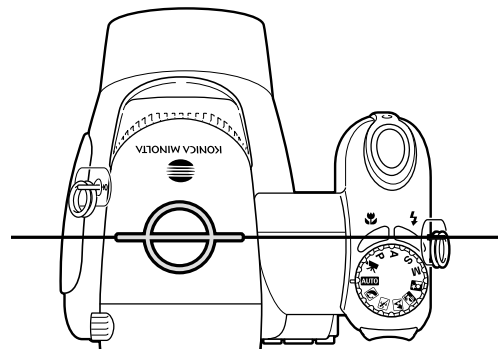

Approximate location of CCD plane

If the flash output was sufficient to illuminate the subject, the OK indicator briefly replaces the flash-mode indicator after the exposure. The access lamp turns red and blinks slowly while the flash is charging; if battery power is low, the monitor turns off during this period.

Camera Notes

If using continuous AF or the sports action subject program with flash, the monitor image reflects the exposure required for the flash when the shutter-release button is pressed partway down. This may cause the monitor image to appear dark in low-light situations.

CAMERA-SHAKE WARNING

If the shutter speed falls below the point where the camera can be safely hand held, the camera-shake warning appears on the LCD monitor. Camera shake is slight blurring caused by subtle hand motion and is more pronounced at the telephoto position of the lens than at the wide-angle. Although the warning appears, the shutter can still be released. If the warning appears, place the camera on a tripod, use the built-in flash, or zoom the lens towards the wide-angle position until the warning disappears.

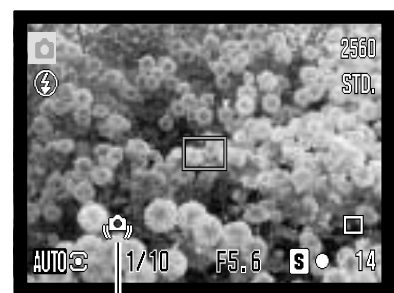

Camera-shake warning

i+ BUTTON

Pressing the information (i+) button changes the monitor display. The display cycles among the standard display, real-time histogram, and live image only.



Standard display

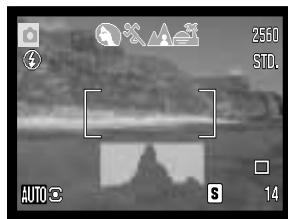

Real-time histogram



Live image only

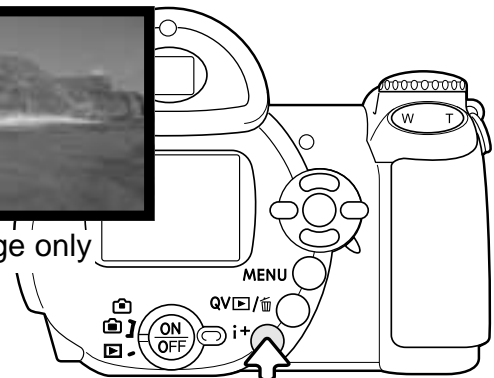

Information button

The real-time histogram shows the approximate luminance distribution of the live image. This histogram cannot show the affect of flash illumination. The histogram of a recorded image may not show the same distribution as the real-time histogram.

ADJUSTING MONITOR BRIGHTNESS

The monitor image can be made lighter or darker. The brightness level can be set individually for viewfinder and direct viewing. Turn the mode switch to the appropriate position. Press and hold the information (i+) button to open the LCD brightness screen.

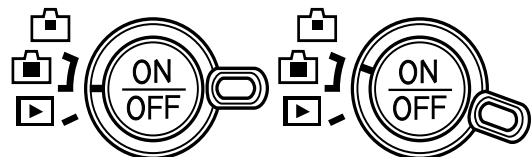

Use the left/right keys of the controller to adjust the brightness; the monitor image changes accordingly. Press the center of the controller or the menu button to set the brightness level.

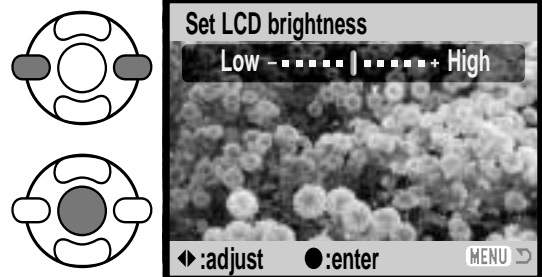

DIGITAL SUBJECT PROGRAMS

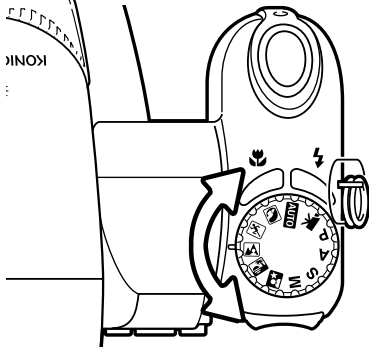

Digital subject programs optimize the camera's exposure, white-balance, and image-processing systems for specific conditions and subjects. Simply turn the exposure mode dial to select the appropriate subject program; the active subject program is displayed in the bottom left corner of the monitor

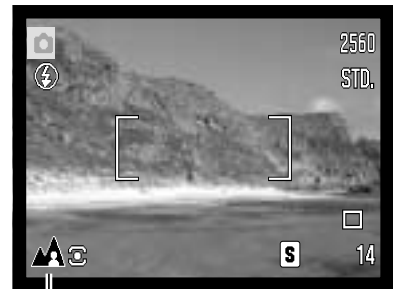

Subject program indicator



Portrait - optimized to reproduce warm, soft skin tones and a slight defocusing of the background. Most portraits look best at a telephoto setting; the longer focal length does not exaggerate facial features and the shallower depth of field softens the background. Use the built-in flash with strong direct sunlight or backlight to reduce harsh shadows.



Sports action - used to capture action by maximizing shutter speeds. The AF system continuously focuses; see page 21. When using flash, the subject must be within the flash range (p. 27). A monopod is more flexible and compact than a tripod when shooting events.



Landscape - optimized to produce sharp, colorful landscapes. Used with bright outdoor scenery.



Sunset - optimized to reproduce rich, warm sunsets. When the sun is above the horizon, do not point the camera toward the sun for prolonged periods of time. The intensity of the sun could damage the CCD. Between exposures, turn off the camera or cover the lens.



Night portrait - for deep, subtle night scenes. The use of a tripod is recommended. When used with flash, the subject and background exposures are balanced. The flash can only be used with close subjects such as with a portrait of a person. When using the flash, ask your subjects not to move after the burst; the shutter will still be open for the background exposure.

BASIC PLAYBACK

Images can be viewed in the Quick View or playback modes. This section covers the basic operations in both modes. The playback mode has additional functions, see page 68.

To view images from the playback mode, turn the mode switch to the playback position (1).

To view images from the recording mode, press the Quick View / delete button (2).

To view images recorded in the internal memory, remove the memory card from the camera.

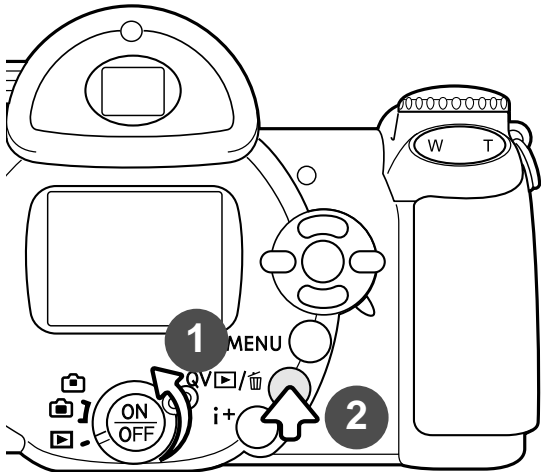

SINGLE-FRAME PLAYBACK AND HISTOGRAM DISPLAY

Mode indicator

Image size (p. 51)

Image quality (p. 51)

Time of capture

Aperture value

Shutter speed

Degree of exposure compensation (p. 41)

Date of capture

White-balance setting (p. 55)

Lock indicator (p. 75)

DPOF indicator (p. 82)

Frame number/ total number of images

Sensitivity setting (p. 59)

Folder number - image file number

Histogram

Folder name

Internal-memory indicator

The internal-memory indicator appears when a memory card is not inserted in the camera.

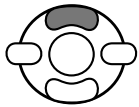

To display the histogram display, press the up key of the controller. Press the down key to return to single-frame playback. The histogram shows the luminance distribution of the image from black (left) to white (right). The 256 vertical lines indicates the relative proportion of that light value in the image. The histogram can be used to evaluate exposure, but displays no color information.

VIEWING AND ROTATING IMAGES

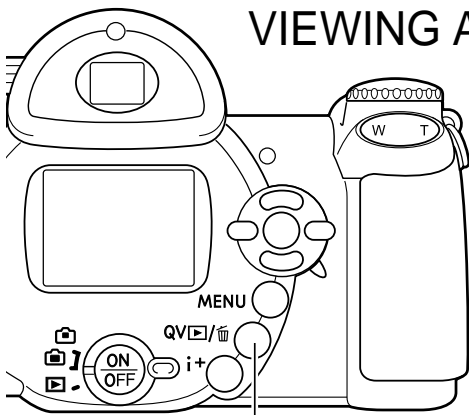

Quick View / Delete button

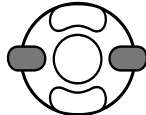

In Quick View or the playback mode, use the left/right keys of the controller to scroll through the images.

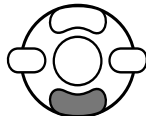

To rotate a vertical image, press the down key to cycle through the three positions: 90° counterclockwise, 90° clockwise, and horizontal.

To return to the recording mode from Quick View, press the menu button or shutter-release button partway down.

DELETING SINGLE IMAGES

The displayed image can be deleted. Once deleted, an image cannot be recovered.



To delete the displayed image, press the Quick View / delete button. A confirmation screen will appear.

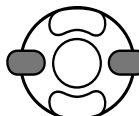

Use the left/right keys to highlight "Yes," "No" will cancel the operation.

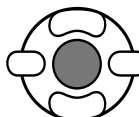

Press the central button of the controller to delete the image.

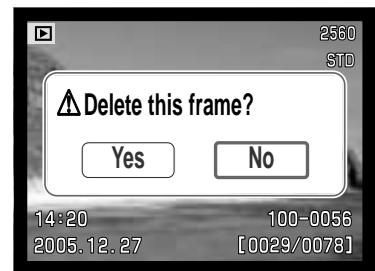

i+ BUTTON

The information (i+) button controls the display format. Each time the button is pressed, the display cycles through to the next format: full display, image only, index playback.

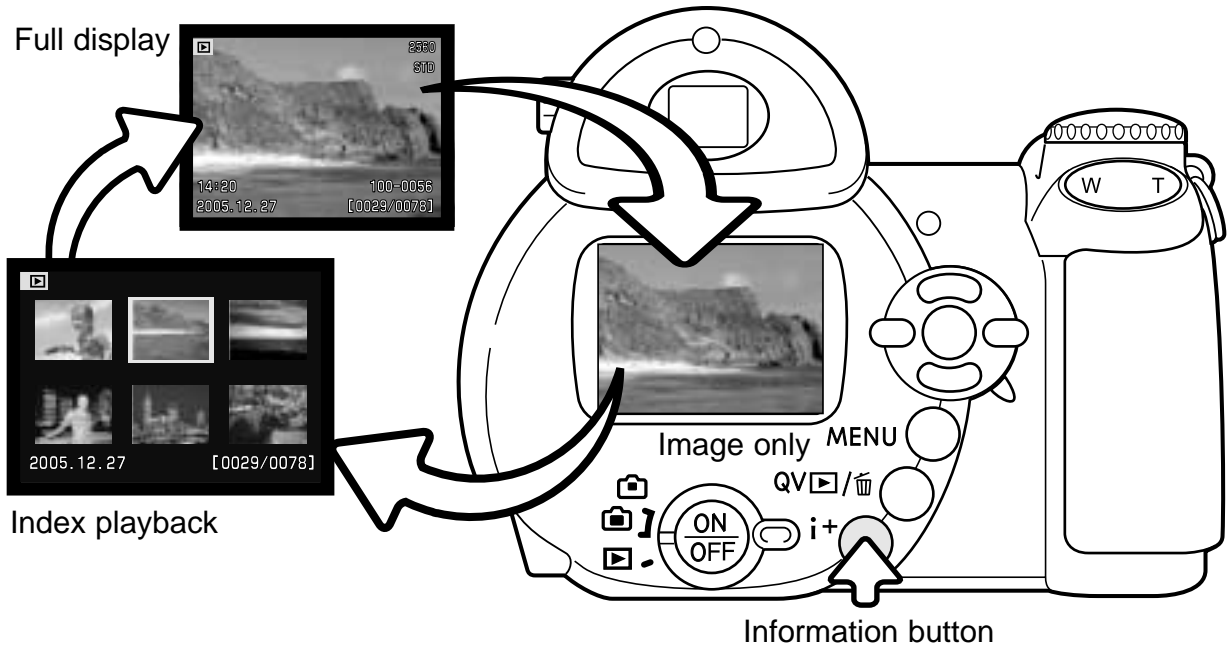

In index playback, the four-way keys of the controller will move the yellow border. When the image is highlighted with the border, the date of recording, the lock and printing status, and the frame number of the image are displayed at the bottom of the screen. The highlighted image can be deleted using the Quick View / delete button (p. 31), or a movie clip can be played by pressing the central button of the controller. When the information (i+) button is pressed again, the highlighted image will be displayed in the single-frame playback mode.

ENLARGED PLAYBACK

In single-frame playback in Quick View or the playback mode, a still image can be enlarged up to 6X in 0.2 increments for closer examination.

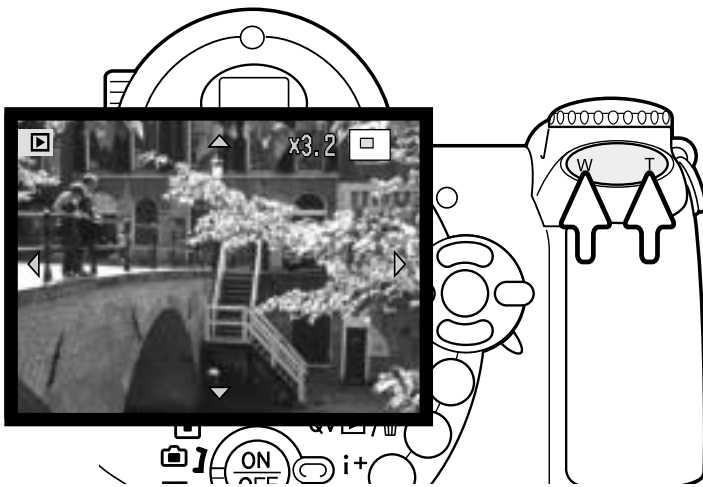

With the image to be magnified displayed, press the right (T) side of the zoom lever to activate the enlarged playback mode. The degree of magnification is displayed on the LCD monitor.

Press the right (T) side of the zoom lever to increase the image magnification. Press the left (W) side of the lever to decrease the magnification.

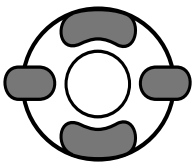

Use the four-way keys of the controller to scroll the image. When scrolling, the arrows in the display will disappear when the edge of the image has been reached.

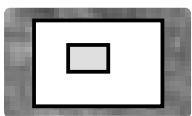

The locator in the top right corner of the monitor indicates the area of the image being displayed.

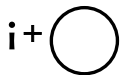

The information (i+) button switches between showing the full display and the image only.



To exit the enlarged playback mode, press the menu button or the central button of the controller.

ADVANCED RECORDING

This section cover the advanced recording features of this camera. Read the basic recording section before moving on to this section.

RECORDING MODE DISPLAY

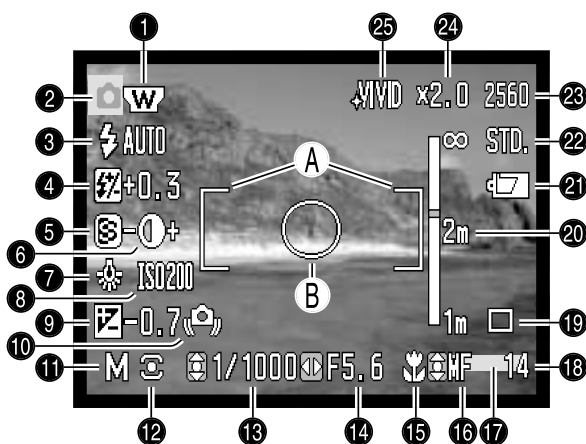

- A. Focus frame
- B. Spot metering area (p. 58)

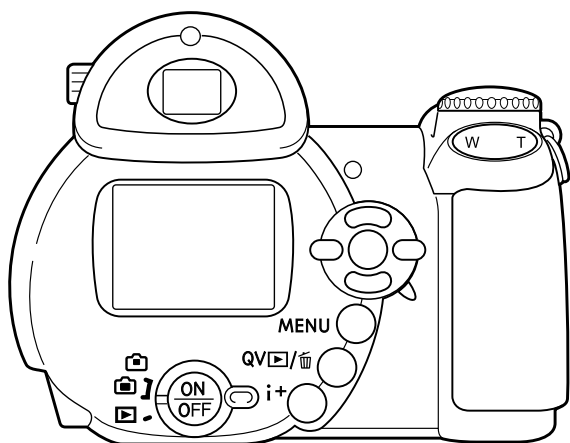

1. Wide-angle converter indicator (p. 90)
2. Mode indicator
3. Flash-mode indicator (p. 26)
4. Flash-compensation display (p. 57)
5. Sharpness display (p. 61)
6. Contrast display (p. 60)
7. White-balance indicator (p. 55)
8. Camera-sensitivity (ISO) display (p. 59)
9. Exposure-compensation display (p. 41)
10. Camera-shake warning (p. 27)
11. Exposure-mode indicator (p. 36 - 38)
12. Metering-mode indicator (p. 58)
13. Shutter-speed display
14. Aperture display
15. Macro-mode indicator (p. 35)
16. Focus-mode indicator (p. 54)
17. Date-imprinting indicator (p. 93)
18. Frame counter (p. 52)
19. Drive-mode indicator (p. 45)
20. Manual-focus scale (p. 54)
21. Battery-condition indicator (p. 14)
22. Image-quality indicator (p. 51)
23. Image-size display (p. 51)
24. Digital-zoom display (p. 53)
25. Color-mode indicator (p. 60)



Internal-memory indicator

The internal-memory indicator appears when a memory card is not inserted in the camera.

MACRO



Macro indicator

Macro mode allows the camera to focus as close as 1 cm (0.4 in.) from the front of the lens or 8 cm (3.1 in.) from the CCD. The focus range changes with the zoom's focal length, see below.

Press the macro button (1) to select the macro mode. Press the macro button again to cancel the macro mode.

The following chart lists the macro ranges. All distances are measured from the CCD.

Wide-angle position: 8 - 107cm (3.1 - 42.1 in.)

26.5 - 30.8mm: 107 - 237cm (42.1 - 93.3 in.)

Telephoto position: 67 - 207cm (26.3 - 81.5 in.)

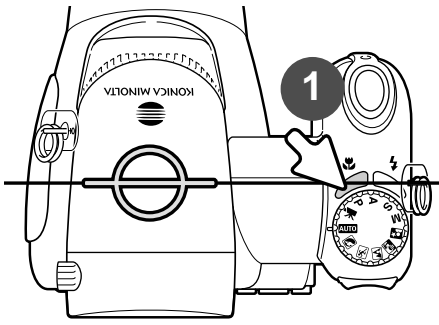

Approximate location of CCD plane

PROGRAM (P) EXPOSURE MODE

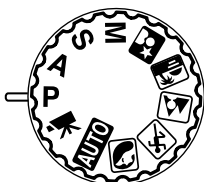

The program exposure mode controls both the shutter speed and aperture to ensure correct exposures. This exposure mode allows photographers to shoot without worry about exposure settings. The shutter speed and aperture values of the exposure are displayed on the monitor when the shutter-release button is pressed partway down. If shutter speed and aperture displays turn red, the scene is beyond the exposure control range of the camera.

APERTURE PRIORITY (A) EXPOSURE MODE

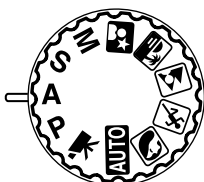

The photographer selects the aperture and the camera sets the appropriate shutter speed to ensure the correct exposure. When aperture priority is selected, the aperture value on the monitor turns blue and a double arrow indicator appears next to it. The flash mode can be set to fill-flash, fill-flash with red-eye reduction, or slow sync. with red-eye reduction (p. 26).

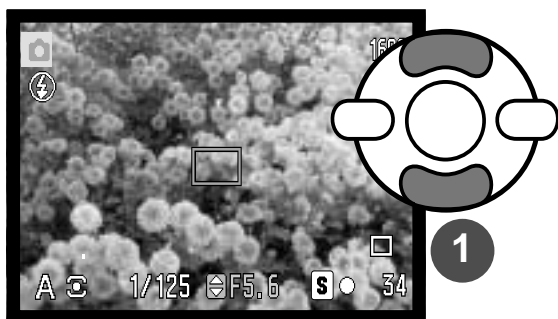

Use the up/down keys of the controller (1) to set the aperture. The aperture has a three stop range. Press the shutter-release button partway down to activate the exposure system; the corresponding shutter speed will be displayed on the monitor.

As the lens is zoomed, the maximum aperture will automatically shift. If the aperture value is beyond the shutter-speed range, the shutter-speed display will turn red on the monitor.

SHUTTER PRIORITY (S) EXPOSURE MODE

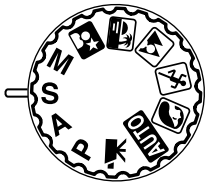

The photographer selects the shutter speed and the camera sets the appropriate aperture to ensure correct exposure. When shutter priority is selected, the shutter speed on the monitor turns blue and a double arrow indicator appears next to it. The shutter speed can be set between 1/2000 and 4 seconds. If the shutter speed is beyond the aperture range, the aperture display will turn red. The flash mode can be set to fill-flash, fill-flash with red-eye reduction, or slow sync. with red-eye reduction (p. 26).

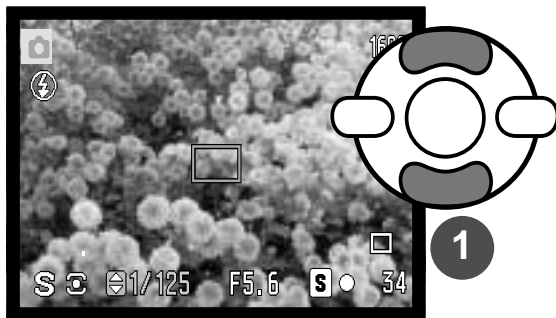

Use the up/down keys of the controller (1) to set the shutter speed. Press the shutter-release button partway down to activate the exposure system; the corresponding aperture will be displayed on the monitor.

Shooting Tips

The shutter speed and aperture control more than the exposure. The shutter speed determines how sharp a moving subject is. The aperture controls the depth of field; the area in front of the camera that appears sharp. For more on exposure controls, see the Short Guide to Photography on page 66.

Camera notes

When the shutter speed is one second or longer, the shutter sound indicates both the beginning and end of the exposure.

MANUAL (M) EXPOSURE MODE

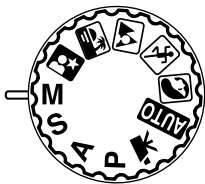

Manual exposure mode allows individual selection of shutter speeds and apertures. This mode overrides the exposure system giving the photographer total control over the final exposure.

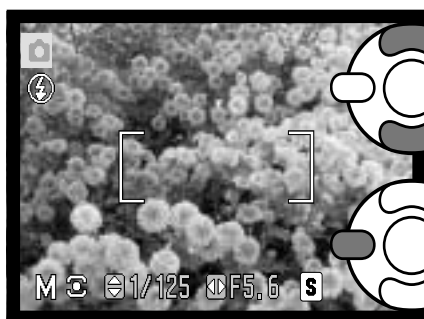

Use the up/down keys of the controller to change the shutter speed.

Use the left/right keys of the controller to change the aperture.

The changes made to the exposure will be visible in the live image on the monitor. The monitor shutter-speed and aperture display will turn red if the image is significantly underexposed or overexposed. If the monitor is black, increase the exposure until the image is visible; decrease the exposure if the monitor is white. When the shutter-release button is pressed partway down, the brightness of the live image may change while the camera focuses.

In manual exposure mode, the auto camera-sensitivity setting will fix the ISO value at 100. The camera sensitivity can be changed in section 3 of the recording menu (p. 59). The flash mode can be set to fill-flash, fill-flash with red-eye reduction, or slow sync. with red-eye reduction (p. 26), but the live image will not reflect the flash exposure.

Camera notes

When the shutter speed is one second or longer, the shutter sound indicates both the beginning and end of the exposure.

EXPOSURE COMPENSATION

The camera exposure can be adjusted to make the final picture lighter or darker by as much as $\pm 2\text{Ev}$ in 1/3 increments. Exposure compensation can only be used with Digital Subject Programs, the P, A, and S exposure modes, and movie recording mode. With movie recording mode, exposure compensation is reset when the camera is turned off. In Digital Subject Programs, P, A, and S exposure modes, exposure compensation remains in effect until reset.

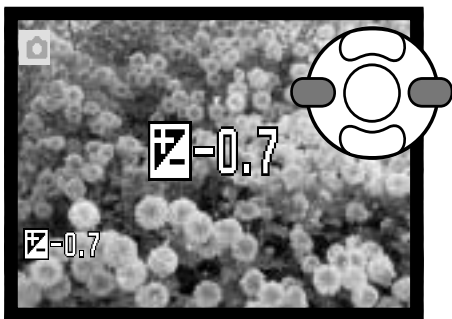

To adjust the exposure, press the left or right controller key; the exposure-compensation screen appears.

Use the left/right keys of the controller to adjust the exposure-compensation value. Changes to exposure are visible in the live image.

Press the shutter-release button partway down or press the central button of the controller to set the adjustment.

When adjusting the exposure, the amount of compensation is shown in EV (p. 50). After the setting is made, the shutter-speed and aperture displays indicate the actual exposure. Because the exposure can be adjusted in fine steps, the shutter speed or aperture value displayed may not change. When set to any value other than zero, the exposure-compensation indicator remains on the monitor as a warning.

Camera notes

Exposure compensation is used when the camera's exposure meter is deceived by high-key or low-key scenes. In the example, the dark water caused the camera to overexpose the image making it too bright and washed-out. By compensating the exposure, detail is brought out in the leaves, and the stones and water appear richer.

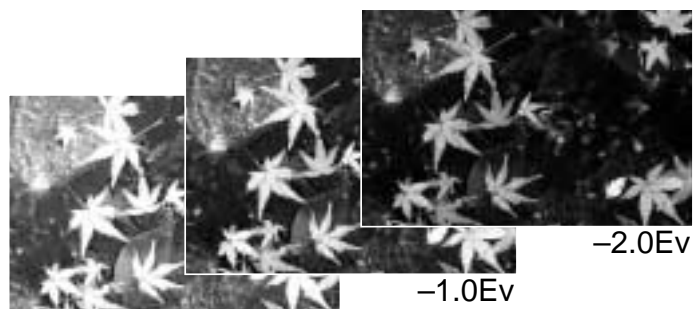

FOCUS AREA SELECTION

Individual focus areas can be selected when recording still images. With auto recording and Digital Subject Programs, focus area selection is reset when the exposure-mode dial is moved to another position or the camera is turned off. In P, A, S, and M exposure modes, the selected focus area remains active until reset.

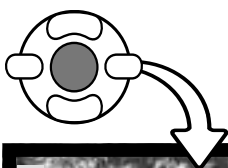

Press and hold the central button of the controller until the three spot focus areas are displayed.

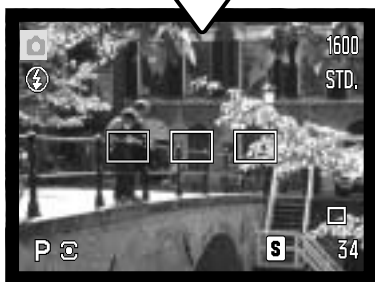

Use the left/right keys of the controller to highlight the desired autofocus area; the active area is blue.

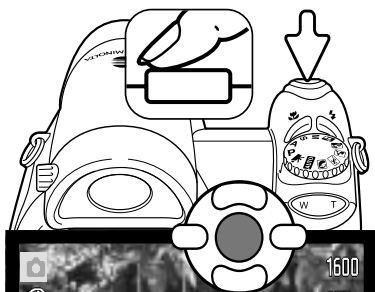
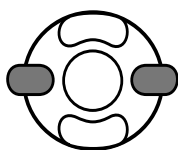

Press the shutter-release button partway down or press the central button of the controller to select the area; the other two areas disappear. Only when a focus area has been selected, can the controller be used for other camera operations.



Take the picture as described in the basic recording section; press the shutter-release button partway down to lock focus and exposure. Press the shutter-release button all the way down to take the picture.

Once a focus area is selected, it will remain active even after the picture has been taken. Press and hold the central button of the controller to return to the standard focus frames.

NAVIGATING THE RECORDING MENUS

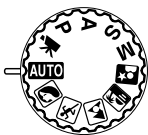

The recording menu displayed varies with the position of the exposure-mode dial. There are four menus depending on if auto recording, movie recording, Digital Subject Programs, or the P,A,S, and M exposure modes are selected. See next page for details.

Pressing the menu button (1) turns the menu on and off. The four-way keys of the controller (2) move the cursor in the menu. Pressing the central button of the controller enters a setting.

MENU  Activate the menu with the menu button.

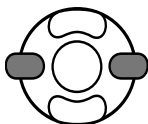

On the P, A, S, and M menu, use the left/right keys of the controller to highlight the appropriate menu tab; the menu changes as the tabs are highlighted.

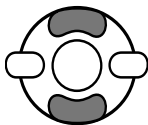

Use the up/down keys to scroll through the menu options. Highlight the option whose setting needs to be changed.

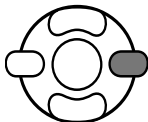

With the menu option highlighted, press the right controller key; the settings are displayed with the current setting highlighted. To return to the menu options, press the left key.

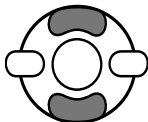

Use the up/down keys to highlight the new setting.

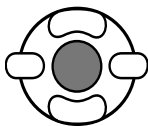

Press the central button of the controller to select the highlighted setting; some options open a selection screen.

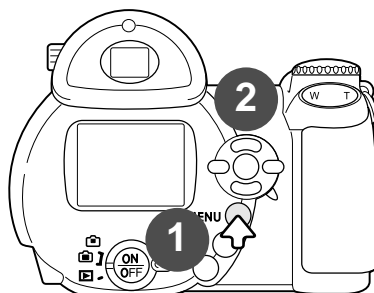

Once a setting has been selected, the cursor will return to the menu options and the new setting will be displayed. To return to the recording mode, press the menu button.

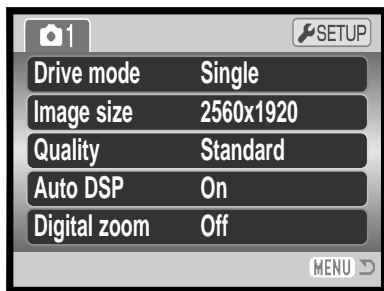
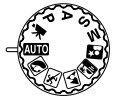

Auto-recording menu

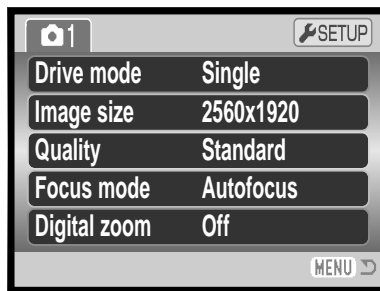
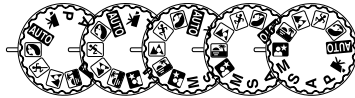

Digital Subject Program menu

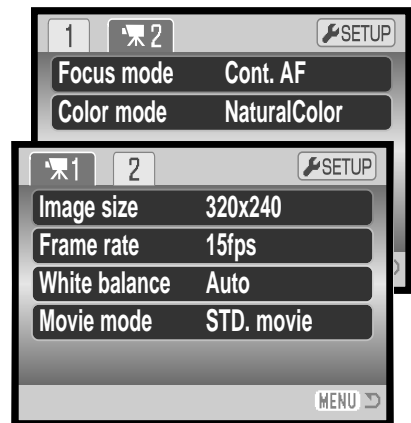

Movie menu

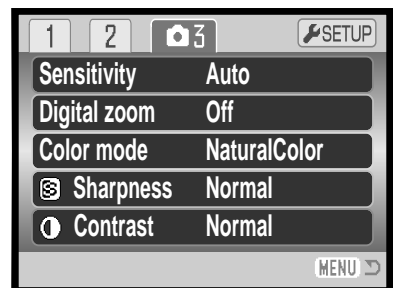
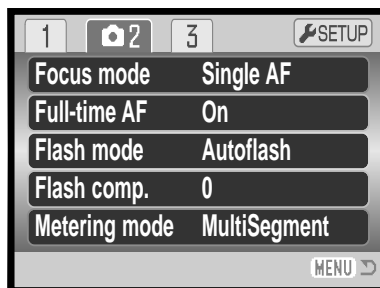
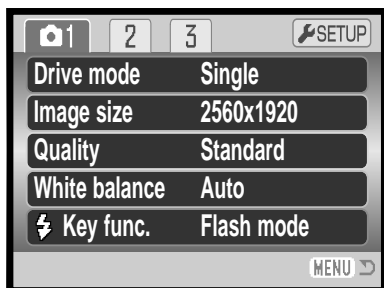

P, A, S, and M exposure-mode menu

Index to menu functions

Auto DSP, 53
 Color mode, 60
 Contrast, 60
 Digital zoom, 53
 Drive mode, 45
 Flash compensation, 57
 Flash mode, 57, 26



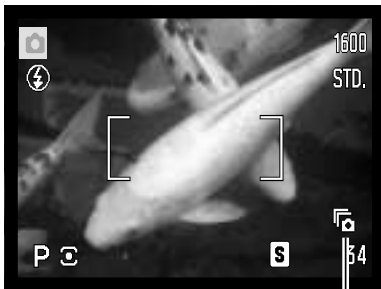

Focus mode, 54
 Frame rate, 64
 Full-time AF, 57
 Image size, 51
 Image size (movie), 64
 Key function, 62
 Metering mode, 58

Movie mode, 65
 Quality, 51
 Sensitivity, 59
 Sharpness, 61
 White balance, 55

DRIVE MODES



The drive modes control the rate and method images are captured. The drive mode is set on all menus except the movie menu. In auto recording mode, the drive mode is reset to single-frame advance when the exposure-mode dial is moved to another position or the camera is turned off. In Digital Subject Programs and P, A, S, and M exposure modes, the drive mode remains in effect until changed. Refer to the following sections for descriptions of the drive modes.

- 
Single-frame advance - to take a single image each time the shutter-release button is pressed (p. 22).
- 
Self-timer - to delay the release of the shutter. Used for self-portraits.
- 
Continuous advance - to take multiple images when the shutter-release button is pressed and held.
- 
Progressive Capture - to continuously record when the shutter-release button is pressed and held. Releasing the button saves the last six images.
- 
Bracketing - to take a series of three images with differing exposures.



SELF-TIMER

Used for self-portraits, the self-timer will delay the release of the shutter for approximately ten seconds or two seconds after the shutter-release button is pressed. The self-timer is set in section 1 of the recording menus (p. 44). The length of the self-timer delay is set in section 4 of the setup menu (p. 96).

With the camera on a tripod, compose the picture so the subject is within the focus frames. Press the shutter-release button partway down to lock the exposure and focus (1). Press the shutter-release button all the way down to begin the countdown (2).

Because focus and exposure are determined when the shutter-release button is pressed, do not stand in front of the camera when taking a self-timer image. Always confirm the focus with the focus signals before beginning the countdown (p. 25).

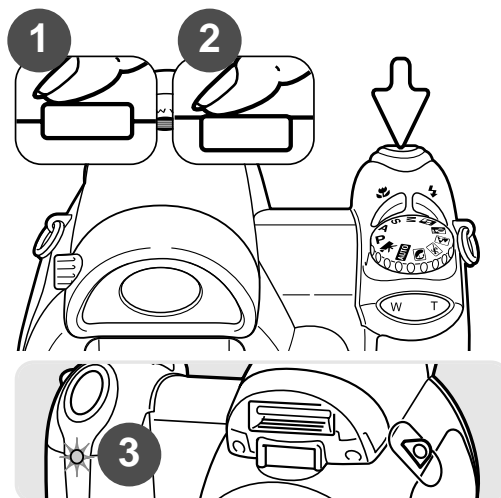

The self-timer is counted down on the monitor. During the countdown, the self-timer lamp on the front of the camera (3) will start to blink and is accompanied by an audio signal. A few seconds before the exposure, the self-timer lamp will blink rapidly. The lamp will glow steadily just before the shutter fires. To stop the countdown, press the right (T) side or the left (W) side of the zoom lever. When using a 10-second delay, the self-timer drive mode is reset to single-frame advance after the exposure. The audio signal can be turned off in section 3 of the setup menu (p. 95).

Shooting tips

The self-timer can be used to minimize camera shake with long exposures. When using the camera on a tripod, photographs of static subjects (landscapes, still-lives, or close-up photographs) can be made with the self-timer. Because no contact is made with the camera during exposure, there is no risk of camera shake caused by the operator.

CONTINUOUS-ADVANCE MODE

The continuous-advance drive mode allow a series of images to be captured while holding down the shutter-release button. The number of images that can be captured at one time and the rate of capture depend on the image-size and image-quality settings. The maximum rate of capture is approximately 1.0 fps. This drive mode is set in section 1 of the recording menu.

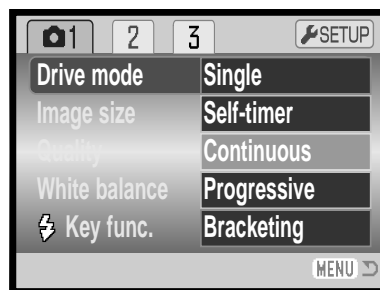

Compose the picture as described in the basic recording operation section (p. 22).

Press the shutter-release button partway down (1) to lock the focus exposure for the series.

Press and hold the shutter-release button all the way down (2) to begin taking pictures; focus is locked with the first frame. When the shutter-release button is pressed and held, the camera will begin recording images until the maximum number has been taken or the shutter button is released.

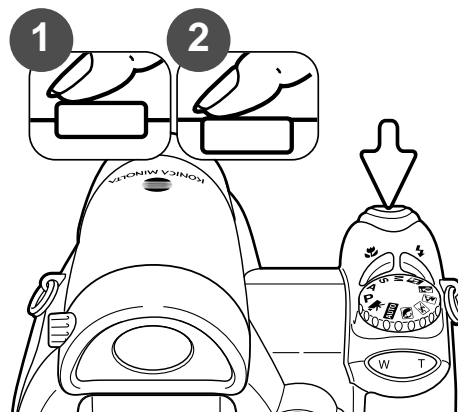

If the continuous AF focus mode (p. 54) is selected, the focus and exposure for the series are not locked. The AF system focuses between each frame.

The use of the built-in flash, the continuous-AF focus mode, or date imprinting (p. 93) reduces the rate of capture. The maximum number of images that can be captured with different image quality and size is as follows:

	2560 X 1920	2048 X 1536	1600 X 1200	640 X 480
Fine	3	3	5	28
Standard	4	7	11	45
Economy	9	13	20	64

PROGRESSIVE-CAPTURE MODE

The Progressive-Capture drive mode continuously records images while holding down the shutter-release button. When the shutter button is released, the last six images stored in the camera's buffer memory are recorded. This drive mode is set in section 1 of the recording menu. When the red low-battery warning is displayed, these drive modes cannot be used. Fine image quality (p. 51) cannot be used in this mode.

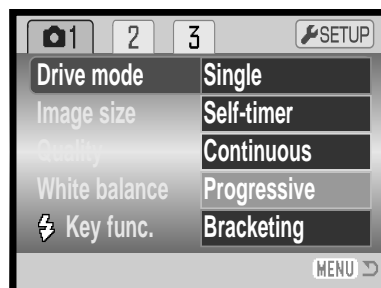

Compose the picture as described in the basic recording operation section (p. 22). Press the shutter-release button partway down (1) to lock the focus exposure for the series.

Press and hold the shutter-release button all the way down (2) to begin taking pictures; focus is locked with the first frame. When the shutter-release button is pressed and held, the camera will begin recording.

Release the shutter (3) to save the images in the camera memory. The Progressive Capture records the last six images saved in the camera's buffer memory. When a series is captured, a thumbnail of each image is shown in an index display while being saved.

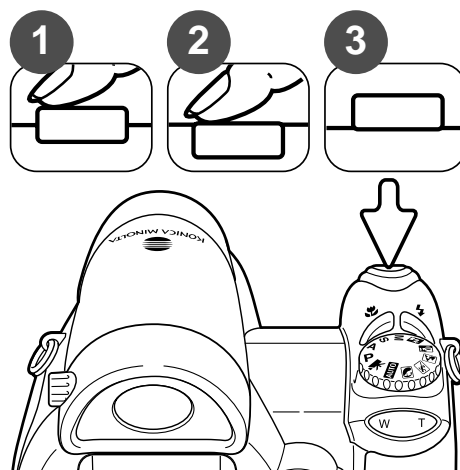

If the continuous AF focus mode (p. 54) is selected, the focus for the series is not locked. The AF system focuses between each frame. The exposure for the series is locked when the shutter-release button is pressed partway down.

The maximum rate of capture is approximately 1.0 fps. The use of the continuous-AF focus mode reduces the rate of capture. The built-in flash and date imprinting (p. 93) cannot be used.

BRACKETING

This mode makes a three-image bracket of a scene. Bracketing is a method of taking a series of images of a static subject in which each image has a slight variation in exposure. The bracketing mode is set in section 1 of the recording menus.

Immediately after selecting the bracketing option on the menu, a selection screen is displayed to select the bracketing increment.

Press the left/right keys of the controller to select the bracketing increment. Press the central button of the controller to set the value. To change the increment, select the bracketing drive mode again with the menu.

Compose the picture as described in the basic recording operation section (p. 22).

Press the shutter-release button partway down (1) to lock the focus exposure for the series.

Press and hold the shutter-release button all the way down (2) to make the bracket series; three consecutive images will be captured. Focus is locked with the first frame.

If the continuous AF focus mode (p. 54) is selected, the focus for the series is not locked. The AF system focuses between each frame. The exposure for the series is locked when the shutter-release button is pressed partway down.

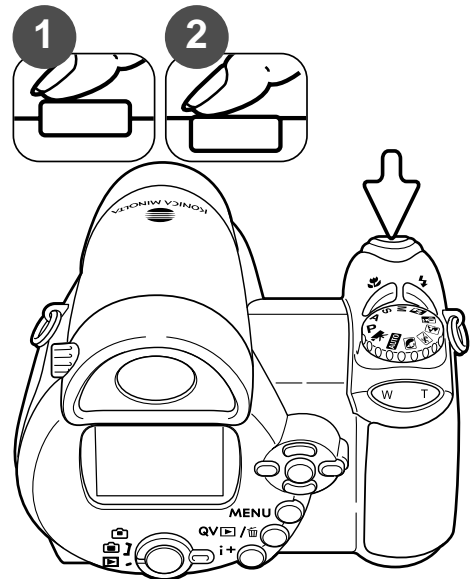
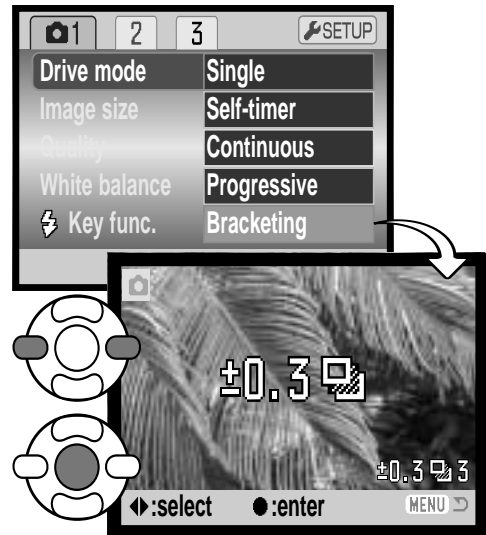

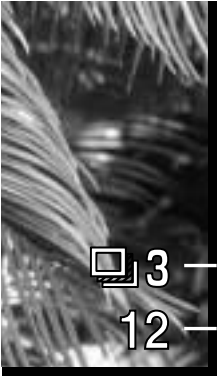

3 — Number of frames in bracketing series
 12 — Frame counter

The remaining number of frames in the bracket series is displayed on the monitor next to the bracketing indicator. If the memory is filled or the shutter button is released before the series has completed, the camera will reset and the entire bracket must be made again. If the red low-battery indicator appears, the bracketing drive mode is disabled. The flash cannot be used with the bracketing drive mode.

The order of the bracket series is normal exposure, underexposure, and overexposure. The exposure bracket can be made in 0.3 or 0.5 Ev increments. The larger the number, the greater the difference in exposure between the images in the bracketed series.

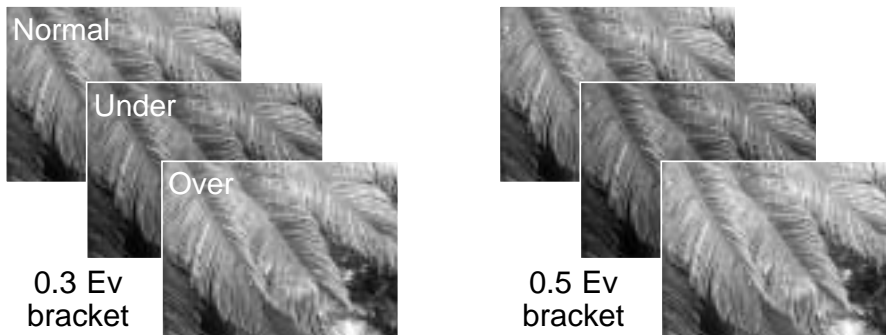

When using exposure compensation (p. 41), the bracketing series will be made in relation to the compensated exposure. Under extreme conditions, one of the bracketed exposures may be inaccurate because it is outside the exposure control range of the camera.

WHAT IS AN EV?

Ev stands for exposure value. A change of one Ev adjusts the exposure calculated by the camera by a factor of two.

+2.0 Ev	4X as much light
+1.0 Ev	2X as much light
±0.0 Ev	Calculated exposure
-1.0 Ev	1/2 as much light
-2.0 Ev	1/4 as much light

IMAGE SIZE AND IMAGE QUALITY

Changing image size affects the number of pixels in each image. The greater the image size, the larger the file size. Choose image size based on the final use of the image - smaller images will be more suitable for web sites whereas larger sizes will produce higher quality prints.

LCD monitor	Number of pixels (hor. X vert.)
2560	2560 X 1920
2048	2048 X 1536
1600	1600 X 1200
640	640 X 480



FINE	Fine - high-quality JPEG image.
STD.	Standard - the default setting. (JPEG)
ECON.	Economy - the smallest file sizes. (JPEG)

Image quality controls the rate of compression, but has no effect on the number of pixels in the image. The higher the image quality, the lower the rate of compression and the larger the file sizes. If economical use of memory is important, use the economy mode. Standard image quality is sufficient for normal usage. The fine mode will produce the highest quality image and the largest image files.

Image size and quality must be set before the picture is taken. Changes are displayed on the LCD monitor. Changes made on one menu affects all exposure modes except movie. Image size and quality must be reset manually. See navigating the recording mode menu section on page 43.

If image size or quality are changed, the frame counter will display the approximate number of images that can be recorded at that setting. Images with differing sizes and qualities can be recorded. The number of images that can be recorded depends on the memory available and the file size of the images. The actual file size is determined by the scene; some subjects can be compressed further than others. See the chart on the following page.

Approximate file sizes.				
	2560 X 1920	2048 X 1536	1600 X 1200	640 X 480
Fine	2460KB	1600KB	1000KB	210KB
Standard	1260KB	830KB	530KB	130KB
Economy	660KB	440KB	290KB	100KB
Approximate number of images that can be stored on internal storage (14.5MB).				
Fine	6	9	14	71
Standard	11	17	28	103
Economy	22	33	48	155
Approximate number of images that can be stored on a 64MB memory card.				
Fine	25	38	61	297
Standard	49	74	117	430
Economy	94	138	203	645

Camera Notes

The frame counter indicates the approximate number of images that can be recorded with the available memory at the camera's image quality and size settings. If the settings are changed, the frame counter adjusts accordingly. Because the counter uses approximate file sizes, the actual image taken may not change the counter or may decrease it by more than one. When the frame counter displays zero, it indicates no more images at the image size and quality settings can be captured. Changing those settings may allow more images to be saved to the card.

With no memory card in the camera, the frame counter indicates the approximate number of images that can be recorded with the available internal memory. When a card is inserted, the frame counter indicates the approximate number of images that can be saved on the card.

AUTO DSP

Automatic Digital Subject Program Selection can be temporarily disabled in the auto-recording menu. When disabled, the program exposure mode is active. If the camera is turned off, Automatic Digital Subject Program Selection is activated.

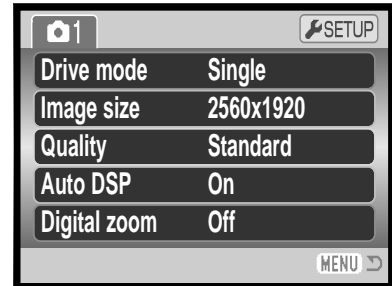

DIGITAL ZOOM

The digital zoom is activated in the auto-recording, Digital Subject Program, and section 3 of the P, A, S, and M exposure-mode menus (p. 44).

The digital zoom extends the power of the telephoto position of the optical zoom by up to 4X in 0.1X increments. The transition between the optical zoom and digital zoom is seamless. When the digital zoom is active, the image magnification is displayed on the monitor and the focus frames change to a single focus area. Because of the degree of magnification, the use of a tripod is recommended.

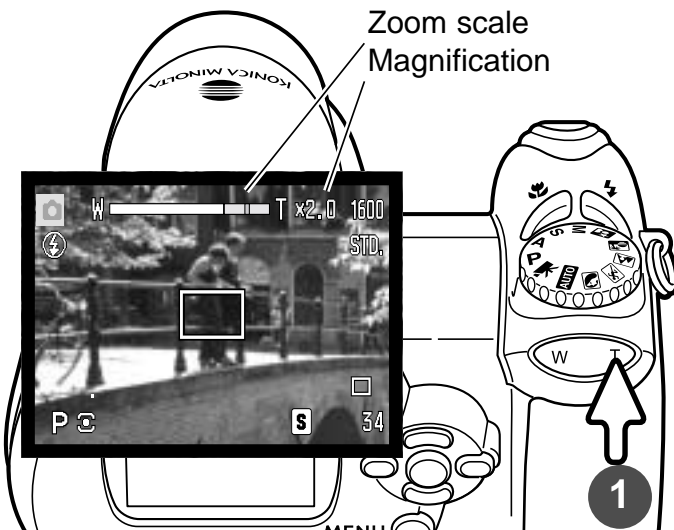

The digital zoom is operated by the zoom lever (1). Press the right (T) side of the lever to zoom in to the telephoto position of the lens. When the digital zoom activates, the image magnification will be displayed on the monitor. Press the left (W) side of the lever to zoom out. After zooming, the zoom scale is displayed briefly. The yellow section indicates the digital-zoom range.

Digital-zoom images are interpolated to the set image size. Some loss of quality may be evident.

FOCUS MODES

This camera has autofocus and manual focus control. The focus mode is selected separately in the Digital Subject Program, movie, and P, A, S, and M exposure-mode menus. The selected focus mode is not reset when the camera is turned off

With the P, A, S, or M exposure modes or movie recording, the autofocus mode can be specified between single-shot AF (**AF-S**) and continuous AF (**AF-C**) in section 2 of the menu (p. 44). Single-shot AF allows the focus to be locked before recording the image, see the basic recording section. Continuous AF continually focuses the camera. When capturing still images, the camera continues to focus when the shutter-release button is held partway down. In movie recording, focus is locked when the shutter-release button is partway down, but it is continually adjusted during recording.

When focusing manually, a scale shows the approximate subject distance. The scale changes depending on the focusing range.

Use the up/down controller keys to focus; the monitor image is automatically magnified by a maximum of 2.5X depending on the digital zoom setting. The live image returns to normal after two seconds, when zooming, or when the shutter-release button is pressed partway down.

When using the shutter-priority, aperture-priority, or manual exposure modes (p. 36 - 38) with manual focus, press the central button of the controller to switch between using the up/down keys to focus or to adjust the exposure. The active function is indicated in blue.

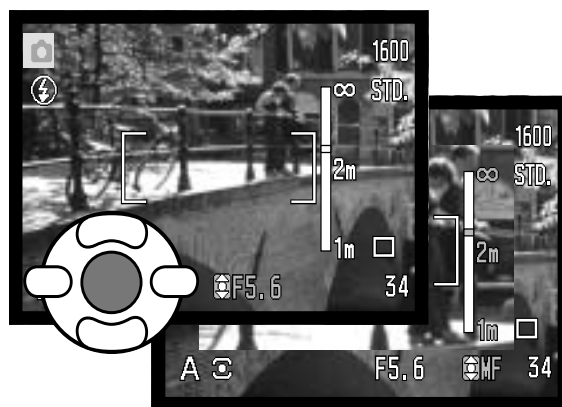
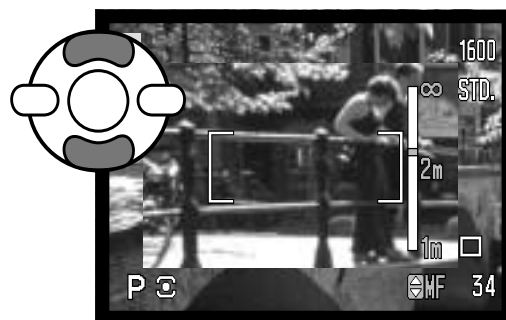

WHITE BALANCE

White balance is the camera's ability to make different types of lighting appear neutral. The effect is similar to selecting daylight or tungsten film, or using color compensating filters in conventional photography. An indicator will be displayed on the monitor if a setting other than auto white-balance is chosen. White balance is set independently in section 1 of the movie, and P, A, S, and M exposure-mode menus (p. 44).

Automatic White Balance





The automatic white balance compensates for the color temperature of a scene. In most cases, the auto setting will balance the ambient light and create beautiful images, even under mixed-lighting conditions. When the built-in flash is used, the white balance is set for the color temperature of the flash.

Preset White Balance

Preset white-balance settings must be set before the image is taken. Once set, the effect is immediately visible on the LCD monitor.

Immediately after selecting the preset white-balance option on the menu, a selection screen is displayed.

Press the left/right keys of the controller to select the preset white balance. Press the central button of the controller to apply it. The following preset options are available:

	Daylight - for outdoor and sunlit subjects.	
	Cloudy - for overcast outdoor scenes.	
	Tungsten - for incandescent lighting: household light bulbs.	
		Fluorescent - for fluorescent lighting: office ceiling lights.
		Flash - for use with the built-in flash.

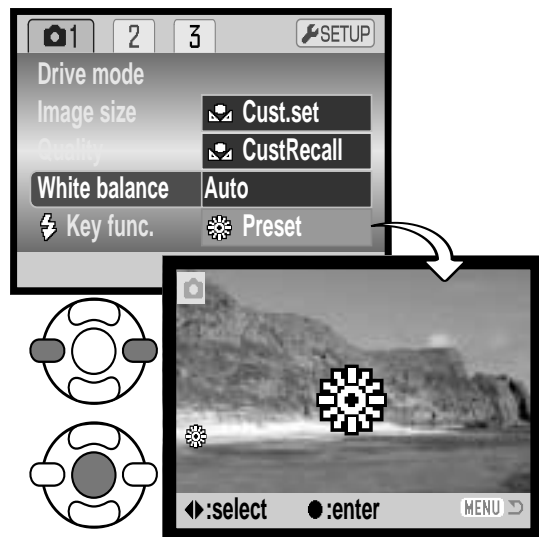

Custom White Balance

Custom white-balance allows the camera to be calibrated to a specific lighting condition. The setting can be used repeatedly until reset. Custom white balance is especially useful with mixed-lighting or when critical control over color is needed. The object used to make a calibration must be neutral. A blank piece of white paper is an ideal surface and can easily be carried in a camera bag.

To calibrate the camera, select custom setup (Cust.set) from the white balance option in section 1 of the movie, and P, A, S, and M exposure-mode menus (p. 44); the custom white-balance calibration screen opens.

Fill the image area with a white object; the object does not need to be in focus. Press the central button of the controller to make the calibration or press the menu button to cancel the routine.

The live view shows the effect of the new white balance setting. The custom setting will remain in effect until another calibration is made or the white-balance setting is changed.

If the custom white-balance setting is required again, select custom recall from the white-balance option of the menu; the last custom white-balance setting will be applied to the camera. The same custom white-balance setting is made and accessed from the movie, P, A, S, and M exposure modes.

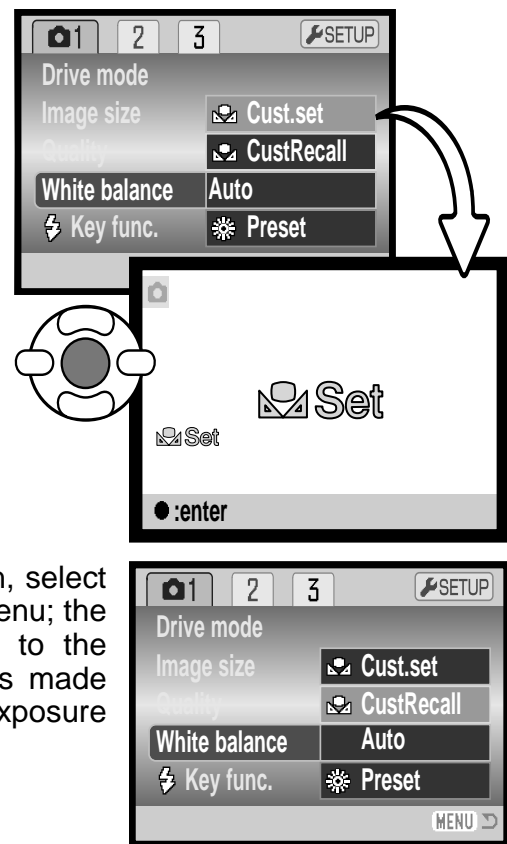

FULL-TIME AF

With full-time AF active, the autofocus systems continually focuses to keep the monitor image sharp. This also reduces the autofocusing time when taking pictures. When the camera is set to manual focus, full-time AF is disabled. Turning the full-time AF function off can help conserve battery power. Full-time AF can be turned on and off in section 2 of the P, A, S, and M menus (p. 44).

FLASH MODE

The flash modes can be changed in section 2 of the P, A, S, and M menus (p. 44). This menu option is used when another function is assigned to the flash mode button, see page 62 on the custom key function. For more on flash modes, refer to page 26.

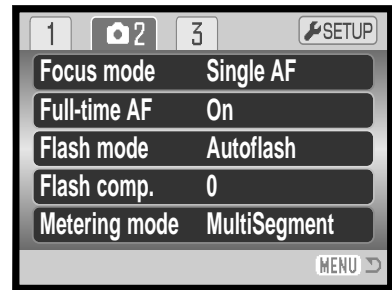

FLASH COMPENSATION

Flash compensation increases or decreases the flash exposure of the built-in flash in reference to the ambient exposure by as much as 2 Ev.

Select the flash compensation option section 2 of the P, A, S, and M menus (p. 44). Use the up/down keys to adjust the degree of compensation (1). Press the central controller button to set this value (2). If any value other than 0.0 is set, an indicator will be displayed on the monitor as a warning.

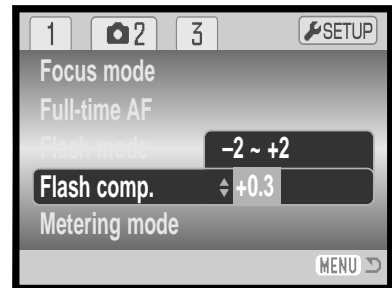

Positive compensation No compensation Negative compensation No flash

Flash compensation changes the ratio between the ambient and flash exposures. When using fill-flash to reduce harsh shadows caused by direct sunlight, flash compensation changes the ratio between the highlights and shadows. The flash affects the darkness of the shadows without affecting the area illuminated by the sun. By decreasing the flash output with a negative Ev setting, the shadows receive less light and are deeper, but retain detail that would be lost without the flash. Using a positive Ev setting will soften or eliminate shadows.

METERING MODES

Metering mode indicators are displayed on the monitor. The metering mode is set in section 2 of the P, A, S, and M menus (p. 44).



Multi-segment metering: uses 256 segments to measure luminance and color. This data is combined with distance information to calculate the camera exposure. This advanced metering system will give accurate worry-free exposures in almost all situations.



Center weighted: a traditional metering method in film cameras. The system measures light values over the entire image area with emphasis given the central region.



Spot metering: uses a small area within the image to calculate the exposure. A small circle appears in the middle of the live image indicating the measuring area. The spot allows precise exposure measurements of a particular object without being influenced by extremely bright or dark areas within the scene.

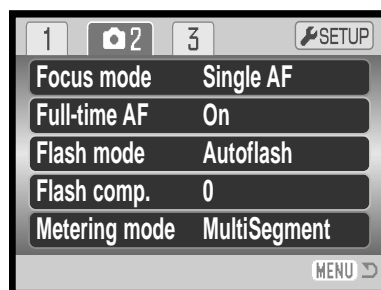

CAMERA SENSITIVITY - ISO

Five camera sensitivity settings can be selected: Auto, 50, 100, 200, and 320; the numerical values are based on an ISO equivalent. ISO is the standard used to indicate film sensitivity: the higher the number, the more sensitive the film. Camera sensitivity is set in section 3 of the P, A, S, and M menus (p. 44).

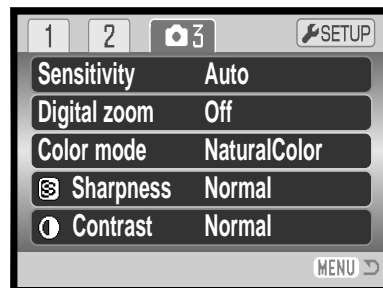

The auto setting automatically adjusts the camera sensitivity to the light conditions between ISO 50 and 160. When any other setting than auto is used, "ISO" and the set value will be displayed on the monitor.

A specific sensitivity setting can be selected. As the ISO value doubles, the camera sensitivity doubles. Like grain in silver-halide film that increases with speed, noise increases with sensitivity in digital imaging; an ISO setting of 50 will have the least noise and 320 will have the most. An ISO setting of 320 may allow the camera to be hand-held in low-light conditions without the need of a flash.

FLASH RANGE AND CAMERA SENSITIVITY

The flash range is measured from the CCD. Because of the optical system, the flash range is not the same at the lens' wide-angle position as it is at the telephoto position.

ISO setting	Flash range (wide angle)	Flash range (telephoto)
AUTO	0.57 - 4.7m (1.87 - 15.4ft.)	1.57 - 4.7m (5.15 - 15.4ft.)
50	0.57 - 2.7m (1.87 - 8.9ft.)	1.57 - 2.7m (5.15 - 8.9ft.)
100	0.57 - 3.8m (1.87 - 12.4ft.)	1.57 - 3.8m (5.15 - 12.4ft.)
200	0.57 - 5.3m (1.87 - 17.4ft.)	1.57 - 5.3m (5.15 - 17.4ft.)
320	0.57 - 6.7m (1.87 - 22.0ft.)	1.57 - 6.7m (5.15 - 22.0ft.)

COLOR MODE

The color mode controls whether a still image is color or black and white. This must be set before the image is recorded. The color mode is set in section 3 of the P, A, S, and M menus and section 2 of the movie menu (p. 44). The live image reflects the selected color mode. The color mode has no effect on image file size.

Natural Color reproduces the colors in the scene faithfully. This mode uses no monitor indicator when active. Vivid Color increases the saturation of the colors in the scene. Black & White produces neutral monochrome images. The sepia mode creates warm-tone monochrome images.

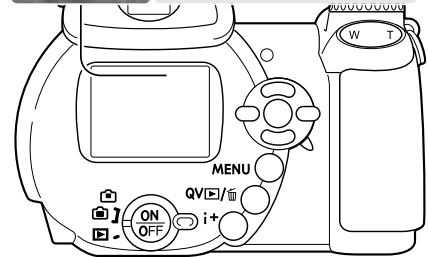

CONTRAST

This function increases or decreases the contrast of the scene in three levels: high (+), normal, and low (-). This can be set in section 3 of the P, A, S, and M menus (p. 44). Any changes made are applied to the live image. If any level except normal is selected, an indicator appears on the monitor as a warning.

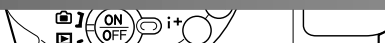
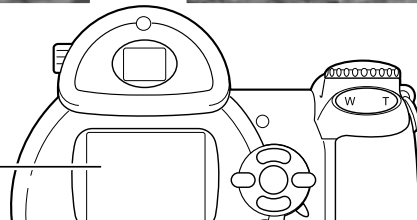
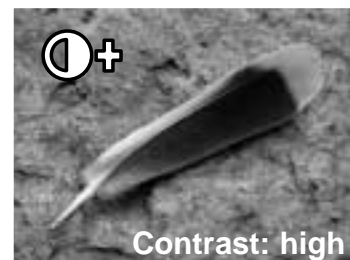
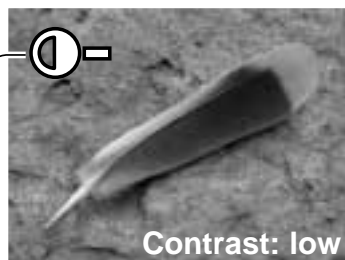

SHARPNESS

Sharpness accents or softens details in an image in three levels: hard (+), normal, and soft (-). This can be set in section 3 of the P, A, S, and M menus (p. 44).

Any changes made are applied to the live image, but may be difficult to see. However, when viewed with a computer, the changes will be evident. If any level except normal is selected, an indicator appears on the monitor as a warning.

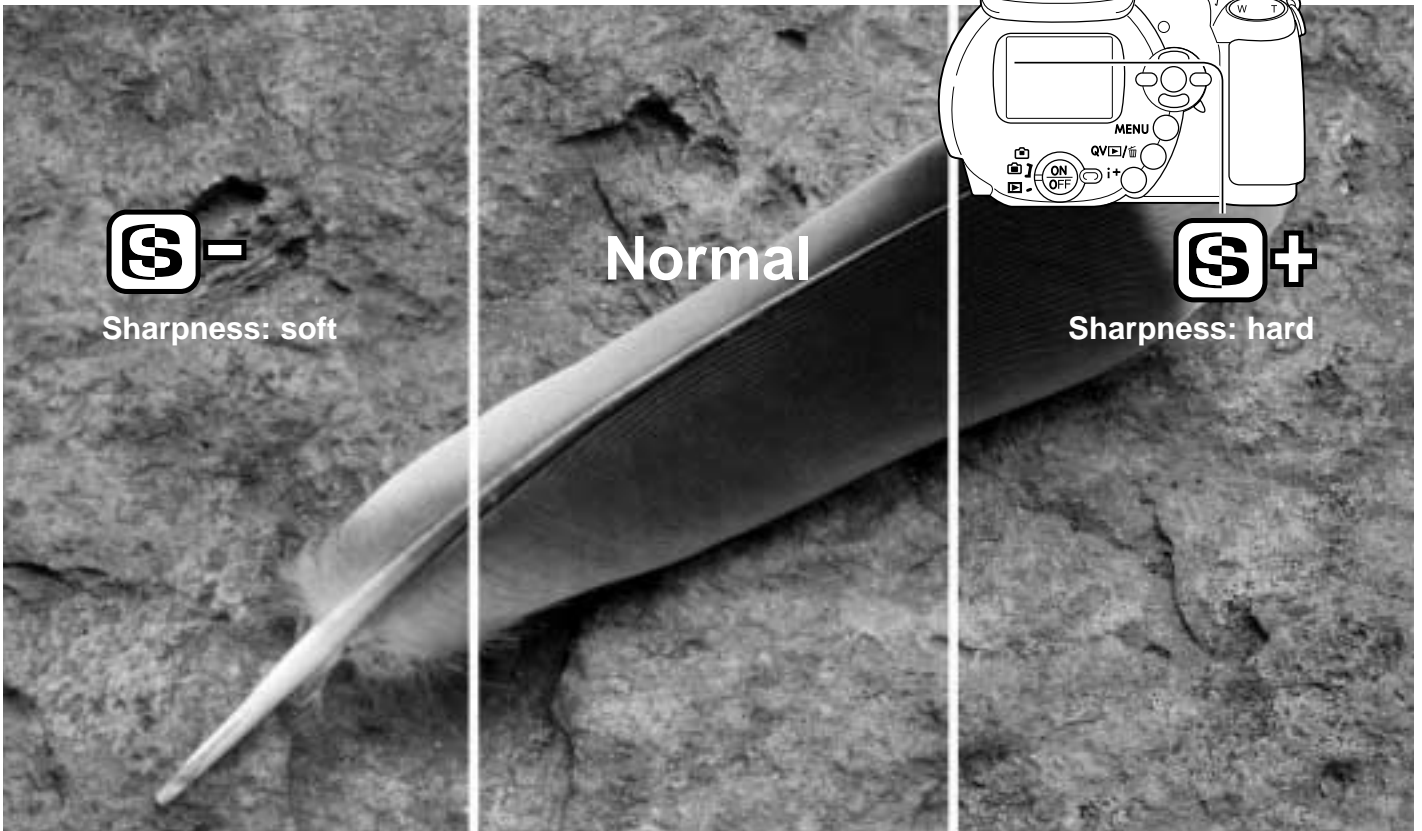
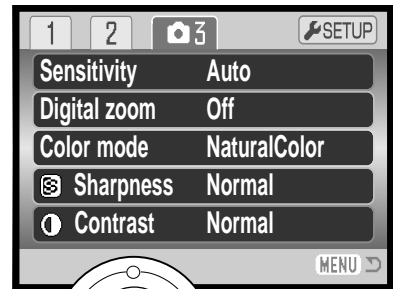

CUSTOM KEY FUNCTION

The function assigned to the flash-mode button can be selected among the flash mode, drive mode, white balance, focus mode, color mode, and sensitivity. This can be set in section 1 of the P, A, S, and M menus (p. 44). The flash mode can also be changed in section 2 of the P, A, S, and M menus.

After selecting the custom key function option on the menu, press the central button of the controller to display the selection screen. Use the four-way keys of the controller to select the function. Press the central button of the controller to set the custom key function. Pressing the menu button cancels the operation without changing the custom key function.

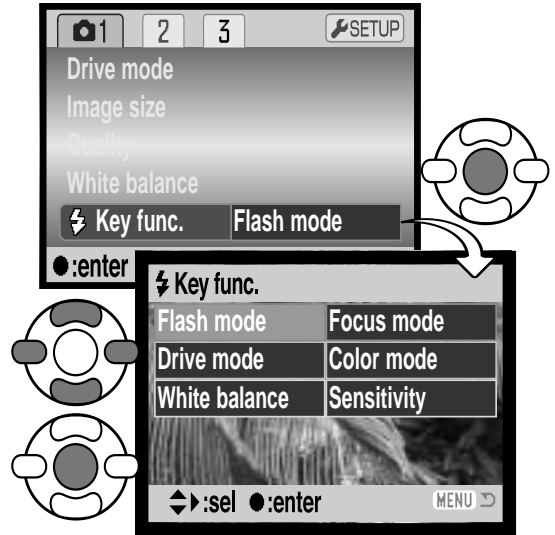

Selection screen

Pressing the flash-mode button changes the function set in the menu. Press the central button of the controller or press the shutter-release button partway down to apply the setting.

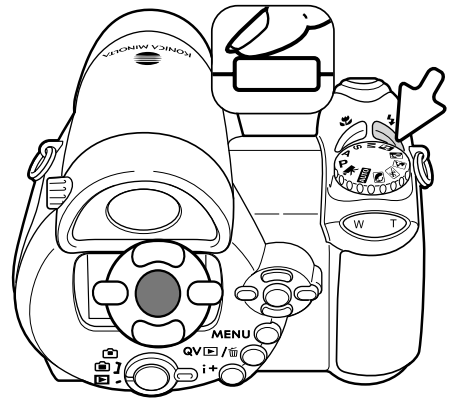

When selecting the bracketing drive mode, or preset white balance, a selection screen appears. Use the left/right keys of the controller to display the bracketing increment or preset white balance, and press the central button of the controller to select it.

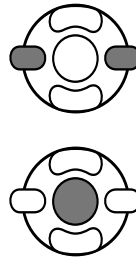

When selecting custom white balance, the calibration screen appears. Fill the frame with a white object and press the central button of the controller to calibrate the camera.

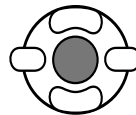
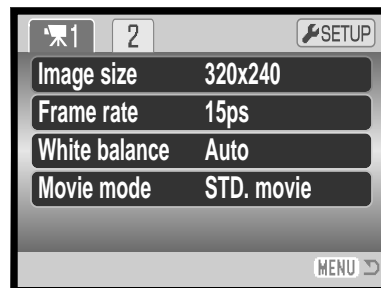

IMAGE SIZE (MOVIE)

Movies can be recorded at two sizes: 640x480 and 320x240. The larger the image size, the higher the image quality and the larger the file sizes. Image size is set in section 1 of the movie menu (p. 44).



FRAME RATE

Movies can be recorded at two frame rates: 15 fps and 30 fps. 640x480 size image can only be recorded at 15fps. The higher the frame rate, the smoother the moving image and the larger the file sizes. Frame rate is set in section 1 of the movie menu (p. 44).

MOVIE FILE SIZES

If image size or frame rate is changed, the frame counter displays the approximate number of seconds that can be recorded. The total time that can be recorded is determined by the available memory and the recording rate. The actual file size is determined by the scene; some subjects can be compressed further than others.

Approximate recording rate		
Frame rate	Image size	
	640 X 480	320 X 240
30 fps	—	670KB/s
15 fps	540KB/s	340KB/s
Approximate number of seconds that can be stored on internal storage (14.5MB).		
30 fps	—	21 seconds
15 fps	27 seconds	43 seconds
Approximate number of seconds that can be stored on a 64MB memory card.		
30 fps	—	91 seconds
15 fps	116 seconds	183 seconds

The writing speed of the memory card may prematurely end the recording of a movie clip. Test the card before important events. Check the Konica Minolta web site for the latest compatibility information:

North America: <http://kmpi.konicaminolta.us>
Europe: <http://www.konicaminoltasupport.com>.

MOVIE MODE

The movie mode option selects the type of movie recorded. Standard produces a normal movie clip. Night Movie uses high camera sensitivity to record under low light levels; camera sensitivity will automatically increase in low light. Image quality can be lower with Night Movies because of the higher sensitivity. The movie mode is set in section 1 of the movie menu (p. 44).